

Research Scholar Program 2001



Dr. Ronald Occhiogrosso, Research Coordinator
Nancy Rifkind, Project Coordinator



Miriam Rafailovich



Jonathan Sokolov

Research Scholar Program 2001

The Garcia Center for Polymers at Engineered Interfaces

is a collaboration of eleven academic, industrial, and government laboratories. The Center was founded in 1996 and is named after the late Queens College professor, Narcisso Garcia, a pioneer in the integration of education and research. The Garcia Center is funded by the **National Science Foundation** as part of its Materials Research Science and Engineering Center (MRSEC) program. The goal of the MRSEC is to combine the instrumentation and expertise of the participating institutions into a coordinated research program on polymers interface science. The principal focus areas include thin films, coatings, nanostructured materials, and composites. These areas address both the fundamental and applied aspects that are relevant to the development of cutting edge enabling technologies for a diverse group of US industries. In the community, the mission of the center is to serve as a valuable resource providing easy access for technological assistance to educational and industrial institutions. For information on the numerous programs that are available please see our web site at: <http://polymer.matscieng.sunysb.edu>

The Research Scholar Program offers the opportunity for high school teachers and students to perform research on the forefronts of polymer science and technology together with GARCIA faculty and staff. Students work as part of focused research teams and are taught to make original contributions of interest the scientific community. In addition to entering national competitions, the students are encourage to publish in refereed scientific journals and present their results at national conferences.

Our goal is to convey to the students the excitement we enjoy daily in research.

The program has no set time limits. Research is a lifetime learning experience, and we hope to remain a resource to our students long after “graduation”.

Sincerely,



Miriam Rafailovich
Professor, Director, Garcia MRSEC

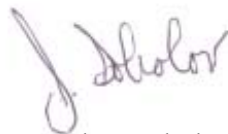

Jonathan Sokolov
Professor, Co-Director, Garcia MRSEC

Research Experience for Teachers

Research Experience for Teachers



Chirakkal Krishnan



Ron Occhiogrosso



Gary Ramonetti

Peter Spellane



Research Experience for Undergraduates

Research Experience for Undergraduates



Jasper Fenton

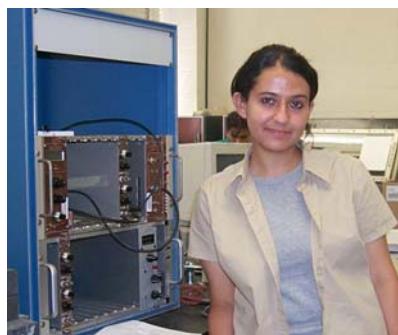

Dina Gewaily



Anshul Shah

Eric Shrag



Ivy Wong

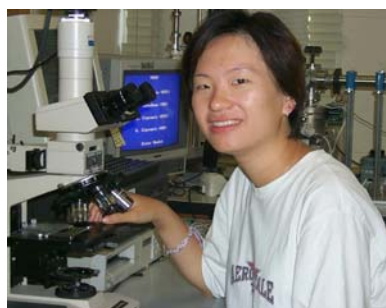

High School Summer Scholars 2001

High School Summer Scholars 2001



Zaigham Abbas



Shira Billet

Jacqueline Brazin



Mordechai Bronner

Blake Campbell

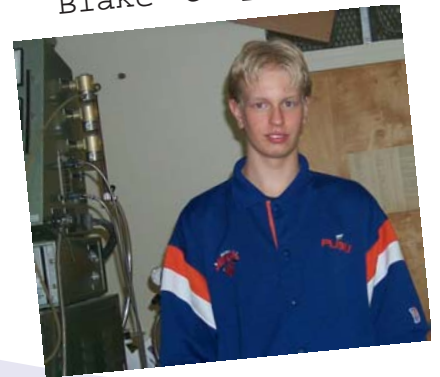

James Conlon



James Cruise

Brooke Forde



James Ferguson



Galambos Arielle



Michael Goldman

Vinitha Jacob



Unaza Kahn



Stephanie Kasuba

Jonathan Katz

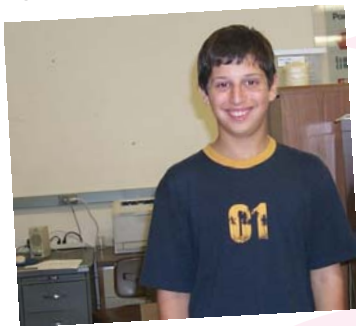

Richard Lee

Aprajita Mattoo



Lisa Marx



High School Summer Scholars 2001
High School Summer Scholars 2001

High School Summer Scholars 2001

Varun Mehta



Eric Petersen



Edmund Palermo



Jessica Rouge



Jessica Slack



Luis Rodriguez

Ying Sun

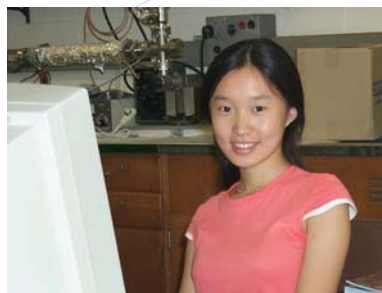

Vivek Vasudevan

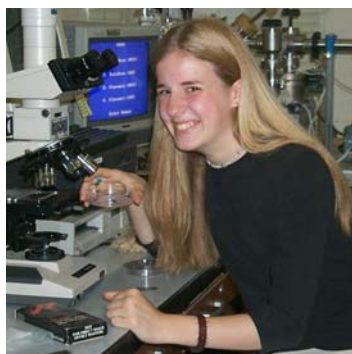

Dora Chana Sosnowik

Felicia Yen

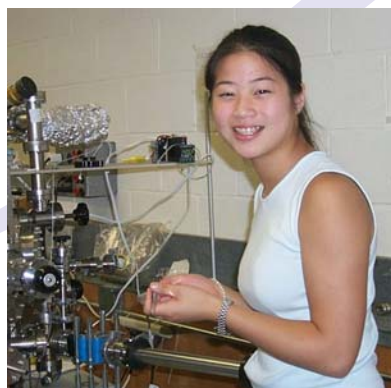

GARCIA CENTER High School Summer Scholars 2001

| | | | |
|--------------------------|---|--|------------------------|
| Zaigham Abbas | <i>Foaming Ethylene Vinyl Acetate 350 in Supercritical Carbon Dioxide</i> | Bay Shore High School | |
| Nina Bai | <i>The Effect of Artificial Clays on the Compatibilization of Polymer Blends</i> | Plainview-Old Bethpage JFK High School | aninani@msn.com |
| Shira Billet | <i>Dewetting Velocity at a Polymer-Polymer Interface as a Function of Lower Layer Viscosity</i> | Stella K. Abraham High School | spillet@aol.com |
| Jacqueline Brazil | <i>Quantitative Hydrophobicity of Polypropylene</i> | HAFTR High School | |
| Mordechai Bronner | <i>Improving Adhesion at Polystyrene and Polymethyl Methacrylate Interfaces Containing Fillers</i> | Rambam Mesivta High School | Crono9999@aol.com |
| Blake Campbell | <i>Foaming Nanocomposite Materials in Supercritical Carbon Dioxide</i> | Bay Shore High School | Roaddemon9@aol.com |
| James Conlon | <i>The Compatibilization of Molded and Bi-Layer Polymer Blends with Supercritical Carbon Dioxide</i> | Bay Shore High School | Dmtrack3@aol.com |
| James Cruise | <i>Properties of Thin Film ICP-type Polymer (PANI-EB and PPE) Coatings and the Oxidation of Aluminum and Copper Substrates</i> | Plainview-Old Bethpage JFK High School | SilvrSrfer@aol.com |
| James Ferguson | <i>Determining the Ratio of Concentration vs. Thickness in SAN Samples</i> | Bay Shore High School | mr100percent@mac.com |
| Brooke Forde | <i>Developing a Surface on Which Cells Can Grow</i> | Brentwood High School | Dogygal113@aol.com |
| Arielle Galambos | <i>Morphology of Amorphous and Crystalline Structures in Diblock Co-Polymer, Poly (styrene-block-ferrodimethylcenyilsilane)</i> | Commack High School | rellicelli@hotmail.com |
| Michael Goldman | <i>Polymer Nanocomposites: PS/PMMA Blending</i> | Rambam Mesivta High School | Goldman1@mail.com |
| Vinitha Jacob | <i>The Effect of Surfaces on DNA Electrophoresis</i> | Hicksville High School | Mj5660@aol.com |
| Unaza Khan | <i>DNA Ring From a DNA Drop</i> | East Islip High School | K2786@yahoo.com |
| Stephanie Kasuba | <i>Fibronectin Fibrillogenesis on Sulfonated Polystyrene Surfaces</i> | Smithtown High School | bfsk@erols.com |
| Jonathan Katz | <i>Protein Adsorption on a Di-block Copolymer Nanopattern</i> | Plainview-Old Bethpage JFK High School | PocketPC84@cs.com |

GARCIA CENTER High School Summer Scholars 2001

| | | | |
|----------------------------|--|-------------------------------|---------------------------|
| Richard Lee | <i>Effects of Octa-Methyl-Poss in the Visco-Elastic Response of Polystyrene</i> | Schreiber High School | Bs241@hotmail.com |
| Aprajita Mattoo | <i>Properties of ICP-type Polymer Thin Films (PANI and PPE) and the Oxidation of Copper and Aluminum Substrates</i> | Jericho High School | appear@aol.com |
| Lisa Marx | <i>Making Giant Magnetoresistant Devices Using Nano-Patterning Methods</i> | Jericho High School | lmblyeyes@aol.com |
| Varun Mehta | <i>Compatibilization of Polycarbonate and Styrene Acrylonitrile-17 Using Clay</i> | Sachem South High School | smartperson@runbox.com |
| Edmund Palermo | <i>Improving the Properties of Polymer Blends with Supercritical Carbon Dioxide</i> | Bay Shore High School | zedp2@aol.com |
| Eric Petersen | <i>Diffusion Dynamics in Free-Standing Polymer Thin Films</i> | Ward Melville High School | Bronco199@aol.com |
| Luis Rodriguez | <i>PS-PMMA Blends with POSS-PMMA Nanocomposite Polymer</i> | Yonkers Roosevelt High School | thekingxl@hotmail.com |
| Jessica Rouge | <i>Properties of Thin Film ICP-type Polymer (PANI-EB and PPE) Coatings and the Oxidation of Aluminum and Copper Substrates</i> | Sachem High School | ClutoJR@aol.com |
| Jessica Slack | <i>Fluid Flow From a DNA Drop</i> | East Islip High School | racewalkingfool@yahoo.com |
| Dora Chana Sosnowik | <i>Melt Fracture as a Function of Molecular Weight</i> | Stella K. Abraham High School | doporop@aol.com |
| Ying Sun | <i>The Effect of Clay on the Compatibilization of Polystyrene and Poly(Methyl Methacrylate) Thin Film</i> | Ward Melville High School | Sunying83@yahoo.com |
| Vivek Vasudevan | <i>Polystyrene and Polymethylmethacrylate Organoclay Nanocomposites</i> | Wheatley High School | VV622@aol.com |
| Felicia Yen | <i>Molecular Computing with DNA Chips and Nanotube Transistors</i> | Half Hollow Hills High School | feliyen@yahoo.com |

GARCIA CENTER Research Experience for Undergraduates

| | | | |
|----------------------|--|---------------------|-----------------------|
| Jasper Fenton | <i>Processing of Polymer Blends</i> | SUNY Stony Brook | jfenton@ic.sunysb.edu |
| Dina Gewaily | <i>Study of Droplet Morphology on Chemically Modified Si Substrates</i> | Brown University | AngelNHP1@aol.com |
| Eric Schrag | <i>The Effect of the Chemical Addition of POSS on Compatibilization Based on Chemical Attachment</i> | Delaware University | snistle@aol.com |
| Anshul Shah | <i>The Effects of Fillers on Adhesion at Polymer Interfaces</i> | Harvard University | Shaha2001@hotmail.com |
| Ivy Wong | <i>Self-Assembling Nanoparticle at the Air/Water Interface</i> | SUNY Stony Brook | iwong@ic.sunysb.edu |

GARCIA CENTER Research Experience for Teachers

| | | | |
|---------------------------------|--|------------------------|-------------------------------|
| Prof. Chirakkal Krishnan | <i>Metallic Nanoparticles</i> | East Islip High School | Krishnan.Chirakkal@sunysb.edu |
| Dr. Ronald Occhiogrosso | <i>Functionalized Nanocomposite Processing</i> | HAFTR High School | rocchiog@juno.com |
| Mr. Gary Ramonetti | <i>Osteoblast Growth on a Sulfonated Polystyrene Surface Treated with Fibronectin.</i> | John Glenn High School | Gramonetti@aol.com |
| Dr. Peter Spellane | <i>Properties of Thin Film ICP-type Polymer (PANI-EB and PPE) Coatings and the Oxidation of Aluminum and Copper Substrates</i> | Life Sciences School | spellane@worldnet.att.net |

Summer Scrap Book



Dr. Krishnan does magic with molecules



Isaac Cohen, Estée Lauder
From Molecules to Makeup

A lighter moment!



Eric practices for a performance at the final day of the summer program.



What! No Nitrogen left?



Ed and Vivek I 'pressing' hard to get data.



Are these results statistically significant?

Don't call the fire department!
Michael at work.



bowling
bowling
bowling
SPORTS PLUS!

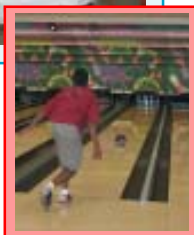
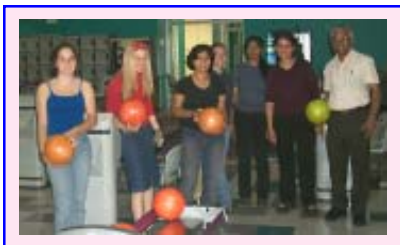

Summer Scholar Program 2000

Calendar of Activities

| | Monday | Tuesday | Wednesday | Thursday | Friday |
|---------------------|--|---|---|--|--|
| Week of 6/26 | 10:00 AM Miriam Rafailovich, Jim Dornicik, Ron Occhiogrosso Welcome & Orientation, Basic Laboratory Procedures | 10:00 AM Miriam Rafailovich, Jim Dornicik, Ron Occhiogrosso Welcome & Orientation, Basic Laboratory Procedures continues | 10:00 AM Journal Club (JC) Ron Occhiogrosso, Model for Article Summaries & Presentations: "Dinosaur Heart Stuns World" | 10:30 -12:00 noon Jim Dornicik Laboratory safety lecture | 10 AM Surface Sophie Delagrangre Micelle Studies of Ps-b-PMMA for Nanopatterning |
| Week of 7/3 | | HAPPY 4th OF JULY | 1-2:30 Ron Occhiogrosso Procedures of data recording and note taking | 11:00AM JC Eric Schrag, "Space Gadgets Identifies Heart Dangers" | 1:00 PM Safety Training Workshop |
| Week of 7/10 | 1-3 PM Lecture/Lab2 Electron Microscopy methods, laser diffraction | 12:00 James Hayward, Presentation of the Bio-Chemistry Research at the Collective Laboratories Group Pizza Lunch | 10AM Review of Polymer Science Basics & Make your own Ice Cream in Liquid Nitrogen Jim Dornicik | 10AM JC "Here, There, and Everywhere: A Quantum State of Mind", Nick Sciacca, "New Finds in South Africa" | 11:00 AM Steve Schwarz/Queens College Research Talk: Kelly Gloor |
| Week of 7/17 | 10:00 AM Dr. Occhiogrosso What is a Supercritical Fluid Anyway (SCF) | | 11:00 AM Dick Stein Univ. of Mass/Amherst Goessmann Professor Emeritus in Chemistry Scattering and Orientation in Polymers | | 10:00 AM Where do recycled polymers go? Trip to American Ecoboard, Manufacturers of Recycled Outdoor Furniture |
| Week of 7/24 | 10:00 AM Dennis Peiffer Exxon Research Engineering Company "What does a Chemical Engineer Do?" Research Talks: J. Ferguson Rebecca Klein Ed Palermo | 10:00 AM JC Jon Thomas, "Adult Brain Can Sprout New Cells"; Grace Cheung, "Stress-Prone? Altering the Diet May Help."; Dina Gewaily, "AIDS Virus Traced to 1675" | 10:00 AM JC Ed Palermo, "Mosquitoes Enlisted Against Disease"; Katherine Hsia, "Why Chicks Aren't All Thumbs"; Pierre Xavier., "Ecosystem Data to Guide Hard Choices" | 11:00 AM Lecture Prof. Rafailovich Error Analysis 2:00 PM Dr. Occhiogrosso Data Regression with Excel | 10:00 AM High School Research Talks: David Yao, Rebecca Klein, James Colon, Ed Palermo |
| Week of 7/31 | | 10:00 JC Max Vaynrub, "How Green are Green Plastics" | 11:00 AM Prof Krishnan SUNY SB Wiz Bang Chemistry | 10:00 JC Rebecca Klein, "Smart Membranes, Intelligent Coatings", Ed Valenta, "Ultra-sonic Hearing in Nocturnal Butterflies" | |
| Week of 8/7 | | 11:00 AM Ron Occhiogrosso, Everything (almost) You Want to Know About: Intel STS, Siemens-Westinghouse, and Other Research-Based Competitions | 10:00 AM JC Aaron Goldman, "Polymer Scientists Engineer Better Remedies"; William Cheng, "Rise of the Robots" | | 10:00 Rebecca Isseroff Langmuir-Blodgett Films of Palladium Nanoparticles High School Research Talks: Aaron Goldman, Nick Sciacca |
| Week of 8/14 | Students Prepare for Presentations | Students Prepare for Presentations | 9:30 Final Poster symposium and end of summer luncheon. | 10:00 AM JC James, Conlon, Kelly Gloor, Heses Shek | 10:00 AM JC David Yao, Anshul Shah, Penina Eisenberg |



Research Scholars Program 2001

- High School Summer Scholars
- Research Experience for Undergraduates
- Research Experience for Teachers

Research Scholars Program 2001

Scientific Presentations

- Processing of Polymers** Session Chair, Anshul Shah
- Zaigham Abbas, Blake Campbell, James Conlon, Edmund Palermo**
Mentored by Dr. Ron Occigrosso
- Jacqueline Brazin**
Mentored by Dr. Ron Occhiogrosso
- James Cruise, Aprajita Mattoo & Jessica Rouge**
Mentored by Dr. Peter Spellane
- Shira Billet & Dora Chana Sosnowik**
Mentored by Sarika Sharma
- Eric Petersen**
Mentored by Song-Feng Li
- Processing Polymers in Supercritical Fluids**
- Hydrophobicity of Microextruded Polypropylene Fibers**
- Coating Metal Surfaces with Inherently Conductive & Chemically Related Polymers**
- Dewetting as a Function of PMMA Viscosity**
- Diffusion Dynamics in Free-Standing Polymer Thin Films**
- Fe Containing Materials and Devices** Session Chair, Dina Gewaily
- Lisa Marx**
Mentored by Kowei Lin
- Arielle Galambos**
Mentored by Yantien Wang
- Making Giant Magneto-Resistant Devices Using Nanopatterning**
- Morphology of Amorphous & Crystalline Structures in Diblock Poly(styrene-block-ferrodimethylcenyilsilane)**
- Coffee Break, 10 Minutes**
- Bio-Materials** Session Chair, Dina Gewaily
- Vinitha Jacob, Unaza Kahn, Jessica Slack, & Dina Gewaily**
Mentored by Dr. Vladimir Samuilov & Young-Soo Seo
- Brooke Forde, Stephanie Kaszuba, & Jonathan Katz**
Mentored by Dr. Nadine Pernodet
- DNA Droplet Morphology & Electrophoresis**
- Structures of Proteins on Polymer Surfaces**

- Nano-Composites** Session Chair, Eric Schrag
- Luis Rodriguez & Eric Schrag**
Mentored by Wenhua Zhang
- Richard Lee**
Mentored by Harry Xavier
- Michael Goldman & Vivek Vasudevan**
Mentored by Mayu Si
- Nina Bai & Ying Sun**
Mentored by Wenhua Zhang
- Varun Mehta & James Ferguson**
Mentored by Dr. Krishnan Chirakkal
- Mordechai Bronner & Anshul Shah**
Mentored by Dr. Dennis Peiffer
- PS-PMMA Blends with POSS-PMMA Nanocomposite Polymers**
- Effect of Octamethyl-POSS in the Visco Elastic Region of Polystyrene**
- Twin Screw Extrusion of Polymer Nanocomposites**
- Effect of Clay on the Compatibilization of PS/PMMA Thin Films**
- Compatibilization of Polycarbonate and Poly(Styrene-co-Acrylonitrile) Using Clay**
- Improving adhesion at Polystyrene and Polymethyl Methacrylate Interfaces Containing Fillers**

Luncheon

Mid-eastern cuisine by Meir's of Ronkonkoma.

Musical Entertainment

Arielle Galambos on the Cello,
playing *Julie-o* by Mark Summer



Brooke Forde and Jessica Rouge on the Flute,
Felicia Yen, and Varun Mehta on the Clarinet, playing
Bourrée II by J.S. Bach

Eric Peterson and Nina Bai on the Violin and
J. Luckner Jerome on the Viola playing *Serenade for Flute,
Violin and Viola Opus 25* by Beethoven and
Mozart Quartet in F #8 K168, played by the above strings
plus Arielle Galambos on Cello.

Foaming Ethylene Vinyl Acetate 350 in Supercritical Carbon Dioxide

Abbas, Z., Campbell, B., Bay Shore High School
Occhiogrosso, R. Ph. D., HAFTR

Abstract:

Elvax 350 or Ethylene Vinyl Acetate (EVA 350) was exposed to supercritical (SC) carbon dioxide to alter their properties in this investigation. These samples were all exposed to SC CO₂ at varying pressures of 982 psi, 1590 psi, and 2971 psi. As shown in figure 1. it was found that the density of these materials varied inversely with the pressure of CO₂ that they were exposed to. In Figure 2. and Figure 3. the Scanning Electron Microscopy (SEM) imaging showed that as CO₂ pressure increased, foaming penetrated more deeply into the core of the polymer.

Illustration of Results:

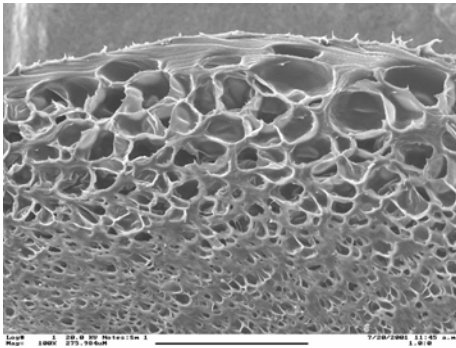

276 μm

Figure 2.
EVA 350 @ ~ 1100 psi
Under SC conditions
(100x)

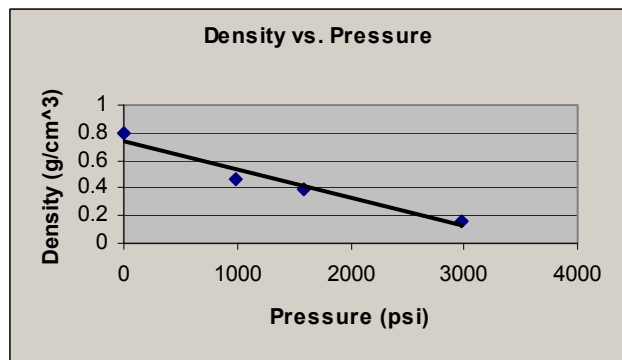
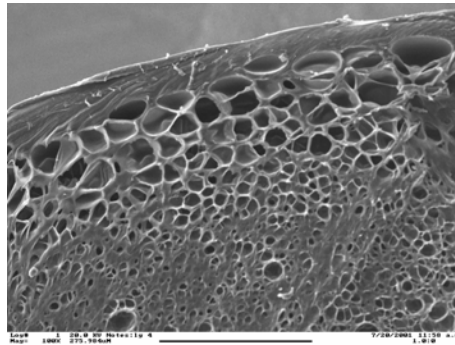

Figure 1.



276 μm

Figure 3.
EVA 350 @ ~ 2500 psi
Under SC conditions
(100x)

**The Effect of Artificial Clays on the
Compatibilization of Polymer Blends**

Nina Bai, Plainview Old-Bethpage John F. Kennedy High School
Miriam Rafailovich, Wenhua Zhang, Shouren Ge
Department of Material Science, SUNY Stony Brook

The addition of clay to immiscible blends has been shown to reduce the phase segregation of normally incompatible polymers.[1] By improving the compatibilization of polymers, the addition of clay allows the formation of new nanocomposites with improved properties such as increased strength, greater clarity, recyclability, and lower density.[2,3] My experiment focused on the effect of two artificial clays, commercially known as Lucentite and Somasif. Various concentrations of these clays (10%-35%, in 5% increments) were added to solutions of PS/PMMA blends. Solutions were then spun onto hydrophobic silicon and annealed at 170C for 24hrs. A second set was annealed for 72 hours. AFM images, contact angle measurements and interfacial tension calculation were taken to determine the extent of compatibilization. Cyclohexane and acetic acid were used to identify the domains of PS/PMMA. Cross sections determined that Young's contact angle is valid.[4] Contact angle measurements were inconsistent possibly due to poor dispersion of the clay in the toluene solvent.[2] Other solvents such as DMF and THF will be tested. Samples annealed for 24 hours will also be compared to those annealed for 72 hours for time dependence.

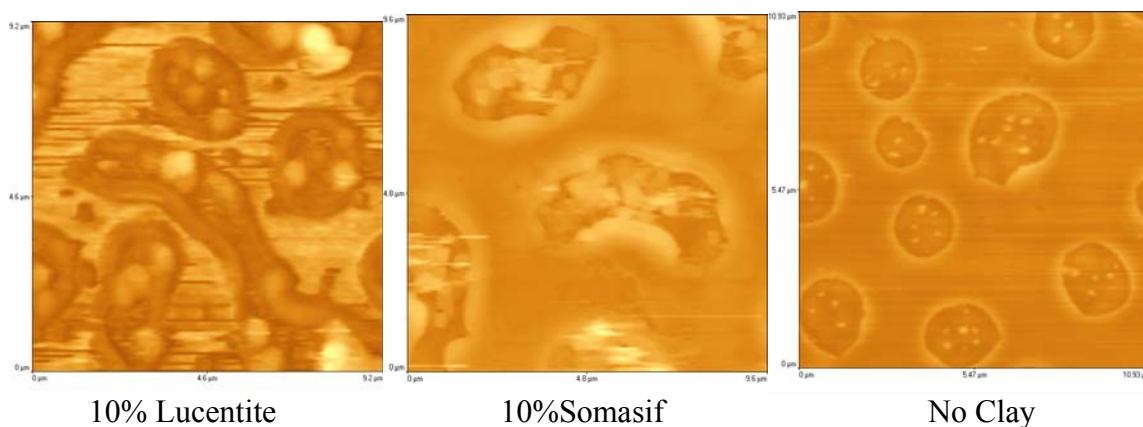

These AFM images show samples dipped in cyclohexane to remove the PS. The "blobs" indicate the PS domains. Clay particles can be seen within these domains in the Lucentite and Somasif images. This shows that the clay particles are located at the interface between PS and PMMA where they may assist compatibilization of the two polymers.

References:

1. Rafailovich, Miriam; Control of Polymer Blend Morphology and Rheology Using Nanoparticles.
2. Co-op Chemical Co.,LTD; *Synthetic Smectite*; www.kowa.com.
3. Macrogalleria; Immiscible Polymer Blends; www.psrc.usm.edu
4. D. Slep, J. Asselta, M. H. Rafailovich, J. Sokolov, D. A. Winesett, A. P. Smith, H. Ade, and Simone Anders; *Effect of an Interactive Surface on the Equilibrium Contact Angles in Bilayer Polymer Films*; Langmuir 2000, 16, 2369-2375.

Dewetting Velocity at a Polymer-Polymer Interface as a Function of Lower Layer Viscosity

Shira Billet, Dora Sosnowik. Stella K. Abraham High School
Sarika Sharma, Miriam Rafailovich,
Department of Material Science and Engineering, SUNY Stony Brook.

We are studying the dynamics of the dewetting of Polystyrene (PS) on poly(methyl methacrylate) (PMMA) as a function of the PMMA lower-layer substrate molecular weight. Brochard-Wyart conducted a theoretical study stating that energy is dissipated in the liquid of lowest viscosity. We proposed that creating a bi-layer would be a good method for measuring the viscosity of sub-micron films. And in accordance with the Brochard-Wyart theory, we intended to prove that when the viscosity of the PMMA lower layer (η_b) is much lower than the PS upper layer viscosity (η_a), dewetting velocity is inversely proportional to η_b . In our procedure, we made different $\sim 1000 \text{ \AA}$ thick PMMA solutions at varying molecular weights (2K, 4K, 27K, 58K, 78K, 255K). These solutions were spun cast onto silicon wafers and 900K PS at approximately 150 \AA was floated onto them. Each sample was annealed 4 times in a closed vacuum system at a constant temperature of 165°C . This temperature was chosen because the surface tension (γ) of polymers is a function of temperature (T), and on a 2-line plot of γ_{PS} and γ_{PMMA} vs. T the polymers intersect at 170°C . Each time a sample was annealed, optical microscopy was used to observe the growing hole radii resulting from dewetting. The lower molecular weight PMMA samples dewetted more rapidly than the higher molecular weight samples. We observed that the 2K and 4K samples dewetted completely after 25 minutes of annealing. The 27K also dewetted rapidly but at a slower rate. The 58K and 78K dewetted at even slower rates in turn, but the 255K still showed no obvious signs of dewetting after 2.5 hours of annealing. Hole growth was found to be proportional to the annealing time for each respective sample. These data suggests that, in fact, dewetting velocity is inversely proportional to η_b .

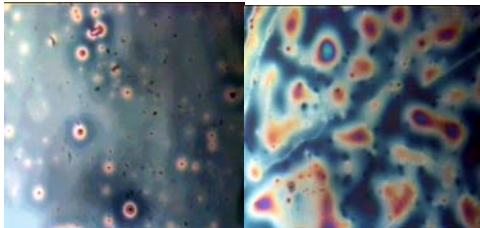

Figure 1- 4K PMMA (under 50x magnification) first after 15 minutes of annealing at 165°C and then after 22 minutes of annealing. After 22 minutes dewetting is already complete

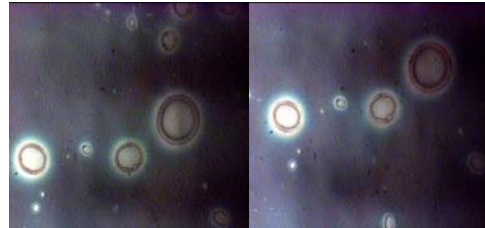

Figure 2- 58K PMMA (under 100x magnification) first after 30 minutes of annealing at 165°C and then after 50 minutes of annealing. Dewetting proceeds much slower at this higher molecular weight

Quantitative Hydrophobicity of Polypropylene

Brazin, J., Occhiogrosso, R ., HAFTR

Miriam Rafailovich, SUNY Stony Brook, Occhiogrosso, N., Chaminade

Polypropylene, one of the most versatile polymers, serves a dual function as a plastic and a fiber. Because polypropylene does not absorb water, polypropylene fibers are used for indoor-outdoor carpeting, usually found near swimming pools and miniature golf courses. Its unique balance of properties including lightness, rigidity, toughness, heat resistance, chemical resistance and high surface gloss enables it to meet industrial needs.

Information on quantitative hydrophobicity was obtained by means of contact angle measurements. The angle formed at the point where a liquid contacts a substrate (liquid or solid) is called the “contact angle.” It was hypothesized that subjecting the polypropylene to super critical CO₂ would decrease its hydrophobicity. Four samples of fiber-- untreated polypropylene and polypropylene exposed to supercritical CO₂ at pressures of 1900 psi, 1100 psi and 800 psi and at a temperature of 96 °F. --were placed on four slides. A drop of 2.0ul of distilled water was put on top of the polypropylene and the contact angle was measured. The untreated sample of polypropylene had an obtuse contact angle that averaged about 111.3°. This proved that polypropylene was hydrophobic. Polypropylene treated at 1900 psi had an average contact angle of 96.6°. This sample of polypropylene was less hydrophobic than untreated polypropylene; however, it was not hydrophilic. The last two samples of polypropylene treated at 1100 psi and 800 psi formed a smaller and an acute contact angle, which averaged 83.3°. Treated polypropylene seemed to be hydrophilic. Further research will be done to determine if polypropylene can be used as a support for the growth of osteoblast cells. Fibronectine proteins, in addition to distilled water, will be tested first to do a complete and thorough review of its effects on polypropylene.

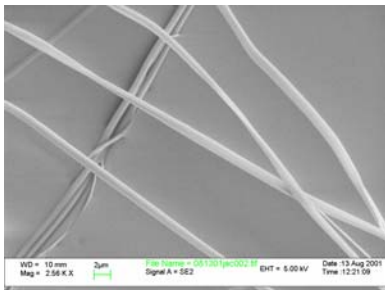

Untreated polypropylene viewed under the Scanning Electron Microscope (SEM).

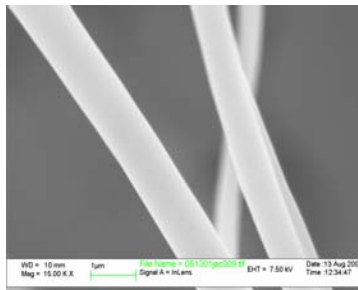

Polypropylene treated at 800 psi at 96 °F viewed under the SEM.

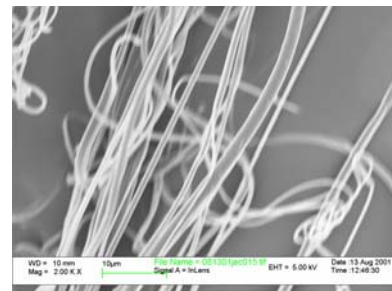

Polypropylene treated at 1100 psi at 96 °F viewed under the SEM.

Improving Adhesion at Polystyrene and Polymethyl Methacrylate Interfaces Containing Fillers

Mordechai Bronner, Anshul Shah, Ward Melville High School/Harvard University, Miriam Rafailovich, Dept. Materials Science and Engineering, SUNY Stony Brook

The purpose of this study was to determine the effects of fillers on the adhesion at polystyrene (PS) and polymethyl methacrylate (PMMA) interfaces and to improve this adhesion. One filler, carbon black, is used in the automotive industry as a strengthening agent in tires, because it improves the mechanical and thermodynamic properties of the material. It is known that tires sometimes fall apart due to tread separation, a result of poor adhesion between the rubber interfaces involved. The effect of carbon black on bulk properties in polymers has been the subject of previous research; my experiments investigated the impact of carbon black on the strength of adhesion in polymers. First, PS and PMMA slabs were molded in a hot press at 150°C. Solutions were created containing varying concentrations of carbon black in toluene, along with PS or PMMA. The solutions were then spun-cast onto the polymer slabs at 2500 rpm for 20 seconds, leaving a thin film of polymer containing carbon black. Ellipsometry was used to confirm a constant film thickness of 1000Å. Each coated slab was then joined with another slab of the same type in the hot press, so that adhesive bonds could form. The resulting “sandwich” sample could then be tested via the Asymmetric Double Cantilever Beam (ADCB) test. This method allows the adhesion to be measured by propagating a crack at the interface, and measuring the length of the crack. Crack measurement allows for the calculation of the fracture toughness, or G_c , a value that quantifies adhesion. Three different types of N299 carbon black, obtained from Cabot Corp., were tested: untreated (standard), heat-treated at 1100°C, and heat-treated at 2400°C. The treated particles had been heated for 90 minutes. The results showed that increasing concentrations of carbon black increasingly diminished the fracture toughness of the PS/PS interface. However, the heat-treated grades of carbon black did not exhibit quite as drastic an effect, particularly the type treated at 2400°C. This finding is significant, because it shows that carbon black, while beneficial to various bulk properties of polymers, can lower the adhesion at polymer interfaces. In tires, poor adhesion between the polymers can lead to tread separation, since the tread must adhere to the rest of the tire. Future work will utilize Atomic Force Microscopy (AFM) to examine interfaces that have undergone adhesive failure and characterize the adhesion. Secondary Ion Mass Spectroscopy (SIMS) will be used to measure the impact of the carbon black fillers on diffusion, a quantity that is directly related to adhesive strength. Further experimentation will also be done with other fillers, colloidal silica and clay, to determine an effect on fracture toughness. This project was funded by the NSF.

Fracture Toughness of PS/PS with Carbon Black at the Interface

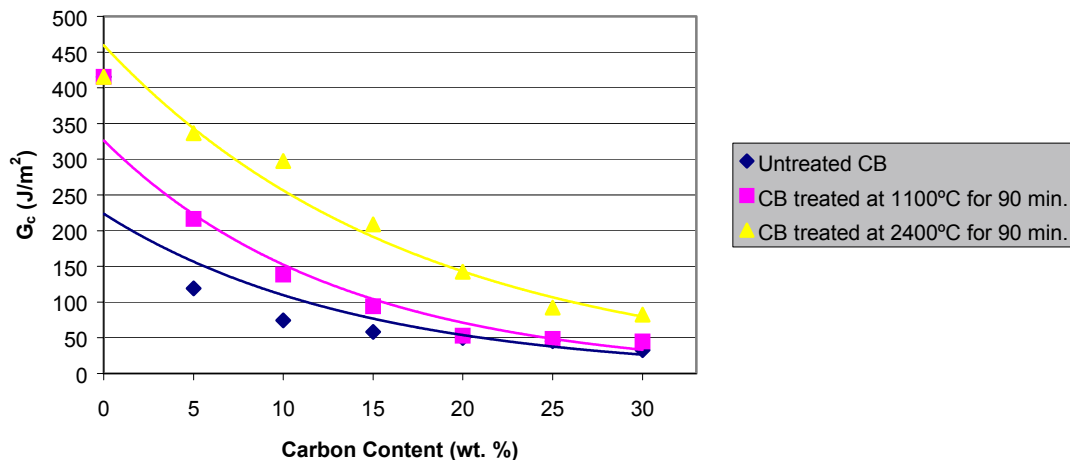

The Compatibilization of Molded and Bi-Layer Polymer Blends with Supercritical Carbon Dioxide

James Conlon, Bay Shore High School, Ronald N. Occhiogrosso, HAFTR,
Miriam Rafailovich, Dept. Materials Science, SUNY Stony Brook

Polymers are defined as long chains of recurring molecules with a molecular weight of more than 1000grams/mole. Most polymers have a very low degree of affinity towards one another. The purpose of this experiment was to increase the compatibility of specific polymers, namely polystyrene (PS) and polymethyl methacrylate (PMMA). The samples of PS and PMMA were tested in both bi-layer samples and in bulk form. The bi-layer samples were procured by spinning a thin film of PMMA on a silicon substrate and floating a layer of PS on top and the bulk sample were molded in a heat press. Also, separate films of 5 polymers (PS, PVP, PS-R-PVP, SAN-26 and Poly(t-butyl acrylate)) were tested to see if swelling of polymers after CO₂ exposure was a common phenomenon. To achieve compatibility between the polymers, CO₂ in its Supercritical Fluid (SCF) state was utilized. The previously mentioned polymers were placed into a vessel designed to achieve high pressures and controlled temperature. The five polymers were tested using Ellipsometry for a swelling of film thickness and three did swell a significant amount. SAN-26 and PS-R-PVP, however, were compressed, probably due to the fact that they were too dense for the CO₂ molecules to penetrate. The bi-layer samples were exposed to CO₂ at various pressures, with temperature held constant at about 95°F. They will be tested for a change in the interfacial width using x-ray reflection. The bulk samples were tested for increased adhesion at the interface by measuring fracture toughness but the CO₂ was found to have a detrimental effect on adhesion. The polymers did however appear to be affected by the SCF. Samples of the polymers were exposed and will be tested using DSC to observe changes in melting point and glass transition temperatures.

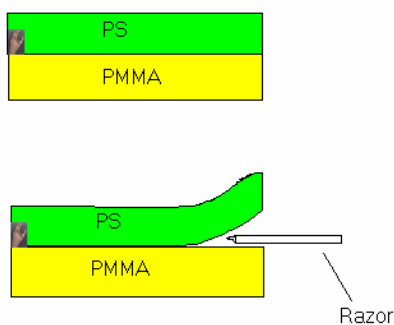

Design of Fracture Toughness Machine

Above: PS/PMMA unexposed

Below: PS/PMMA @ 1500 psi

Coating Metal Surfaces with Inherently Conductive and Related Polymers

James Cruise III, Plainview High School, Jessica Rouge, Sachem High School, Aprajita Mattoo, Jericho High School, Peter J. Spellane, Life Sciences Secondary School, Miriam Rafailovich, SUNY Stony Brook

The objective of our experimentation is the inhibition of metal corrosion utilizing polymer coatings. This destructive redox chemistry applies to all facets of everyday life. By coating thin ($\sim 500\text{\AA}$ - $\sim 2000\text{\AA}$) spuncast films of polyaniline and polyphenylene ether onto copper and aluminum vapor deposited silicon wafers, we hope to retard the synthesis of oxide layers (rust). Our samples were plasma etched with a Reactive Ion Etch to homogenize the topography of the metal surfaces prior to testing. The samples were then coated with a polymer layer and examined using the atomic force microscope (AFM). The AFM was employed to calculate the roughness and degree of coat compatibility. By utilizing the National Synchrotron Light Source at Brookhaven National Laboratory, we were able to calculate the thickness of oxide layers with X-ray reflectivity. The Secondary Ion Mass Spectrometer was then manipulated to determine the chemical composition of the sample nanolayer.

Research was carried into the field of conductivity as well. PPE was spun cast onto Si wafers at varying concentrations (.5%, 1%, 2%). The thickness of the films were measured and the conductivity was tested using a four point probe. We hope to determine the correlation between film thickness and conductivity of PPE, as well as temperature variance.



PPE coating on Cu.



PANI on hydrophilic Si

Processing of Polymer Blends

Jasper Fenton, Henry White, Miriam Rafailovich, SUNY Stony Brook

Polymer immiscibility is the major problem hindering recycling efforts. Sorting of polymers in the recycling sludge is very expensive. Failure to separate immiscible polymers causes mechanical failure of components fabricated from recycled polymers. On the other hand when polymers are miscible, combining them enhances the properties of the materials. Since most polymers are immiscible, a third component known as a surfactant must be found which will induce miscibility. The goal of this study is to develop a surfactant that is both effective in compatibilizing a large variety of polymers and is sufficiently inexpensive as to make it economical to use in recycling. To achieve this goal we selected an equal mixture of polystyrene (Styrofoam) and polymethylmethacrylate (Plexiglass) since they are common plastics used in our everyday lives. Thin films of polymer blends were prepared on modified silicon substrates by spin casting. Inorganic nanocomposites such as surface modified clays (Cloisite 6A, Southern Clay) were added to some of the mixtures. The films were evaluated after annealing by atomic force and friction force microscopy in order to evaluate the effectiveness of the clay in inducing compatibility.



Determining the Ratio of Concentration vs. Thickness in SAN Samples

James A. Ferguson, Bay Shore Senior High School, Dr. R. Occhiogrosso, HAFTR

SAN, (poly Styrene-co-Acrilo Nitrile), is a commonly used polymer in materials science. It can be found in household recyclable plastics, flashlights, and synthetic rubber.

In researching SAN, it is spun cast onto a thin wafer of silicon at a certain thickness. To get a specific thickness, a specific concentration must be used. To facilitate future experiments, a Concentration vs. Thickness graph can be plotted with the results of several spin casting tests of different concentrations. Once the graph is plotted for a certain SAN, other scientists can use this to get a specific thickness as an end result. This can be repeated for other molecular weights of SAN.

SAN must be precisely measured in grams to make a specific concentration of solution. Using this solution, a specific thickness of polymer can be spun cast onto a wafer of silicon. Knowing the exact amount of polymer needed for a precise thickness takes out the guesswork of finding the necessary concentrations. These results can be published on a web site so other researchers can use these findings.

The following is the Concentration vs. Thickness regression for SAN-17

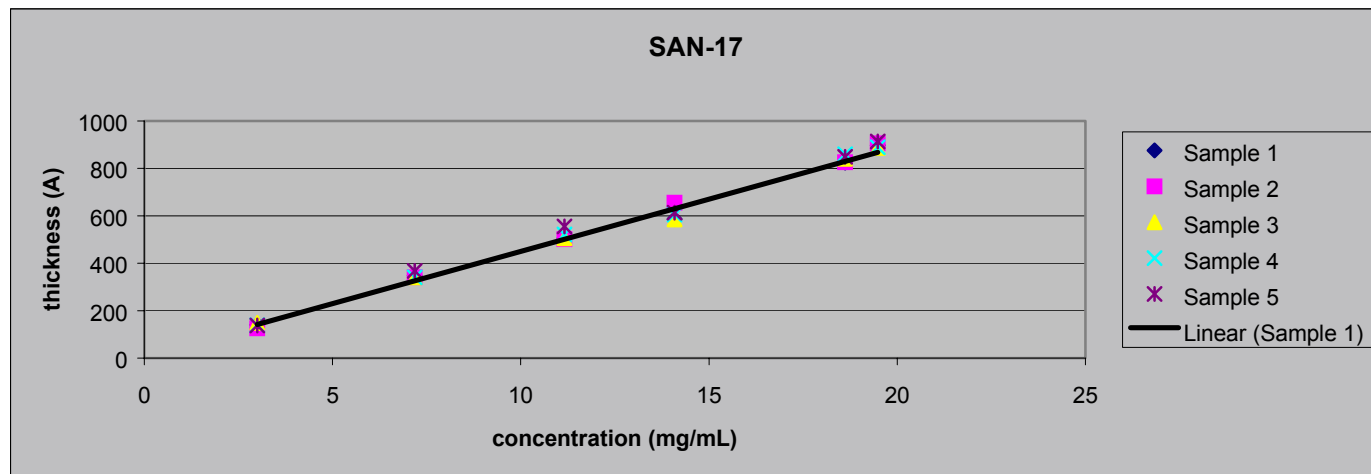

Developing A Surface On Which Cells Can Grow

Brooke Forde, Brentwood High School,
Miriam Rafailovich, Nadine Pernodet,
Dept. Material Sciences and Engineering, SUNY Stony Brook

Sulfonated Polystyrene (5.3%, 9.53%, 18%, 24%, 35%) was the most successful of the eight polymers that were experimented with. The Sulfonated Polystyrene (SPS) was dissolved in Dimethyl Formamide (DMF) in a ratio of 1:10 (1gm/10ml). The SPS was spun onto different surfaces. These surfaces were silicon, gold, chromium, nickel, copper and silicon gratings (# 3 and 8). The surfaces were then incubated in the appropriate protein solution. Fibronectin was the most prevalent protein because it is a cell adhesion protein; it is an insoluble glycoprotein that serves as a linker in an extra cellular matrix. Albumin is the most abundant protein in the blood plasma and helps to transport hormones and drugs. Other proteins in the body include, Elastin, Collagen and Aggregan. If these proteins grow on the SPS and the cells grow on the matrix formed by the proteins, the more successful the experiment would be. The SPS is a productive surface because sulfur is a part of the chemical structure of amino acids, proteins. The Fibronectin will, ideally, form an extra cellular matrix to Sulfonated Polystyrene on bone prosthesis with the Albumin, a calcium binding protein. This matrix will be readily acceptable for other proteins and essentially, the body. The surface, Sulfonated Polystyrene has shown much promise in making implanted bone prosthesis more readily accepted by the body.

Fig. 1: Fibronectin lattices as viewed under an atomic force microscope.

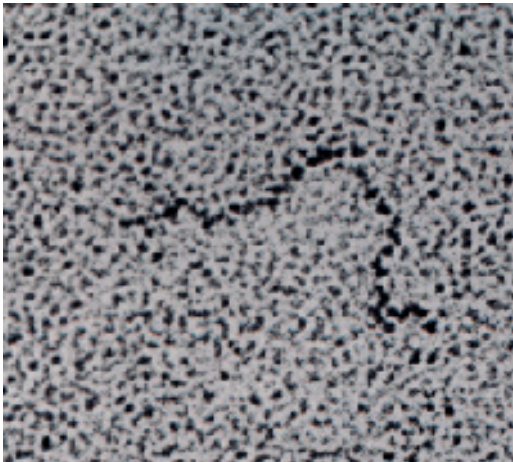
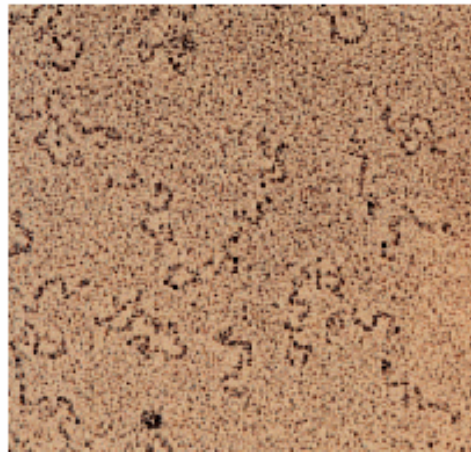

Fig. 2: Topographical friction of fibronectin lattices as viewed under an atomic force microscope.



Morphology of Amorphous and Crystalline Structures in Diblock Co-Polymer, Poly (styrene-*block*- ferrodimethylcenylsilane)

Arielle Galambos, Commack High School

Yantian Wang, Department of Materials Science and Engineering, SUNY Stony Brook

Abstract

A diblock copolymer is a special kind of polymer such that one sequence of one of the polymers is covalently bonded to one sequence of the other polymer. What is most significant about the diblock copolymer studied is that it contains iron. Poly(styrene) alone forms amorphous structures, however when it is in the diblock copolymer with poly(ferrodimethylcenylsilane) it is possible that crystalline structures could form. This would be useful since iron in the diblock copolymer could be magnetic. To study the possibility of crystalline structures with the diblock copolymer, solutions of the diblock copolymer were made at various concentrations in toluene. The solutions were spun onto silicon wafers, and the thicknesses were determined to be 204 Å, 362 Å, 792 Å, and 1043 Å, as measured by an ellipsometer. These samples were then annealed at 160 °C for one hour and then decreased to 95 °C for 24 hours. Annealing was done in a high vacuum oven at 10^{-9} torr. It was necessary to use a high vacuum oven to prevent oxidation from occurring, which would be the case if the substrates were exposed to air while the reactions were taking place. These films were studied before and after annealing using the Atomic Force Microscope, which studies the topography of the film as well as the friction of the surface. Additional solutions were also made by adding Poly(styrene) to the diblock copolymer in a 1:1 ratio. These solutions were also made at various concentrations and spun on silicon wafers. The film thickness was determined to be 1186 Å, 610 Å, 363 Å, and 280 Å and were annealed at 170 °C for 3 days and then decreased to 90 °C for 36 hours. The samples were also studied prior to annealing using an AFM.

Samples which have been annealed for 3 days have shown signs of crystal growth which can be seen with the optical microscope (Figure 1). However, samples which have been annealed for only 24 hours did not show signs of crystal growth (Figure 2), as seen with the AFM.

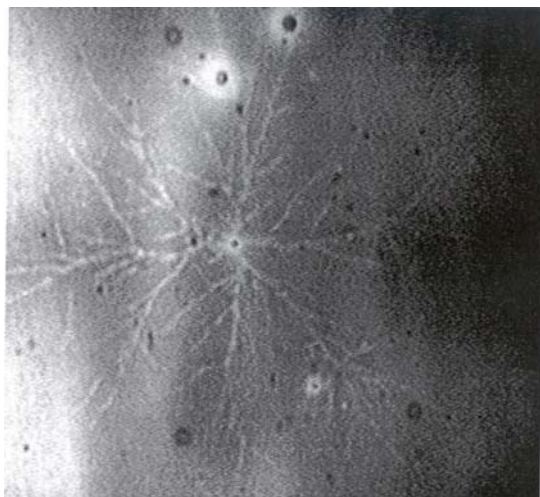

Figure 1

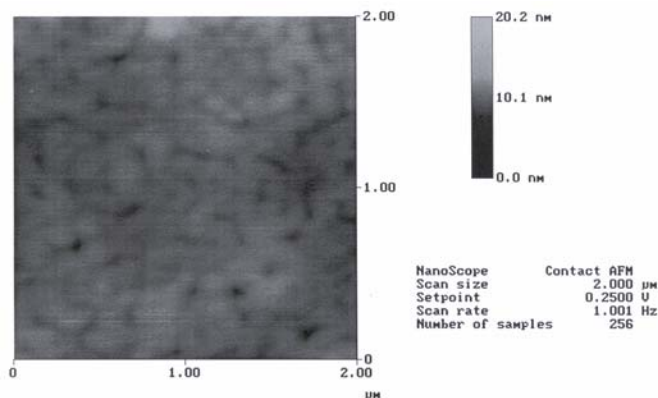

Figure 2

Study of Droplet Morphology on Chemically - Modified Si Substrates

Dina Gewaily, Brown University;
Unaza Khan, Jessica Slack, East Islip High School;
Young-Soo Seo, C.V. Krishnan, V. Samuilov, and Miriam Rafailovich, Department of
Materials Science and Engineering, SUNY-Stony Brook

Several studies in the past have been devoted to the examination of contact line deposits in an evaporating drop. For example, Deegan *et al* [1,2] considered a number of substrates of varying chemical compositions and different solutes in a rather large size range. However, only neutral and round solutes were accounted for. Hence, substrate-solute interactions were blatantly overlooked.

Substrate-solute interactions are likely to play a large role in DNA adsorption onto flat surfaces. Not only is DNA electrically - charged, giving it the ability to interact strongly with surfaces, but it is also a long chain of molecules, which can have different configurations based on surface interaction. It is important to study the adsorption characteristics of biological molecules such as DNA on flat silicon wafers for many scientific research applications (i.e. “electrophoresis on a chip” [3]).

In this project, the evaporation profile of Lambda DNA (bacteriophage lambda, 500 micrograms/mL, molecular mass 3.15×10^6 Daltons, 48,502 base pairs in length, pH 8.0, 10 mM Tris-HCl and 1mM EDTA) solution droplets on silicon wafers treated with chemicals such as octadecyltrichlorosilane, polyvinyl pyridine, and polystyrene-polymethylmethacrylate blend was explored. Profiles were compiled as a result of contact angle and mass loss measurements made as a function of time. Electrostatic interaction studies within the droplet were also carried out using DNA in tris buffer in the presence (and absence) of salts such as LiCl, NaCl, NaI, NaBr, and KCl. To obtain images of the adsorbed DNA solution droplet, confocal and atomic force microscopies were utilized. Through these studies, we hope to make definitive and quantitative conclusions regarding DNA droplet morphology formation and evaporation kinetics.

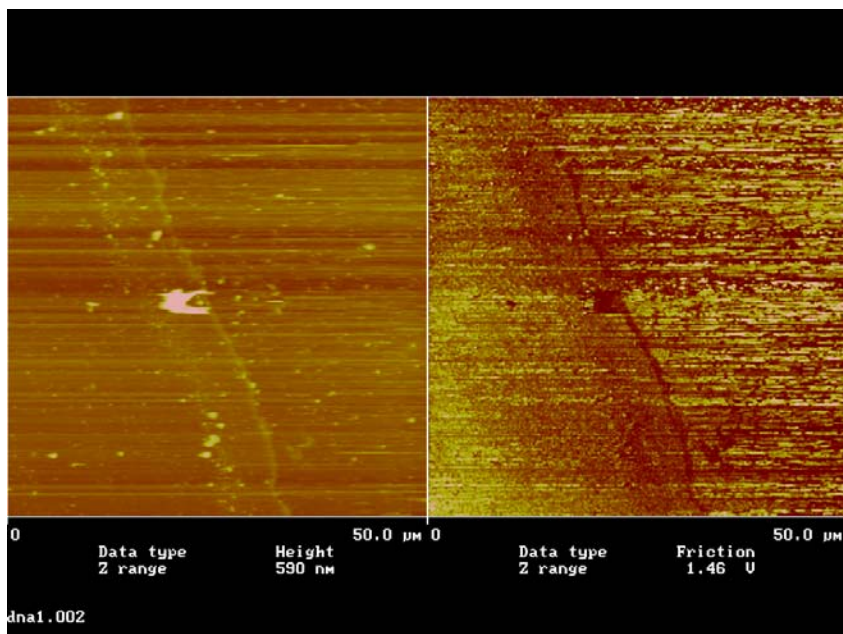

Atomic Force Microscopy (AFM) images in topological (left) and friction (right) mode of adsorbed DNA ring on Octadecyltrichlorosilane-covered Si surface

[1] R.D. Deegan *et al*, *Nature*. **389** (1997) 827.

[2] R.D. Deegan *et al*, *Physics Review E*. **62** (2000). A1.

[3] D. Gewaily, Young-Soo Seo, V. Samuilov, and Miriam Rafailovich. *Study of Droplet Morphology and Its Application for DNA Electrophoresis on a Chip*. Not published.

Polymer Nanocomposites: PS/PMMA Blending

Michael Goldman, Rambam Mesivta High School, Vivek Vasudevan, Wheatley High School, Mayu Si, Miriam Rafailovich, SUNY Stony Brook

Polymer Nanocomposites are becoming an increasingly prominent topic in the realm of Material Science Engineering. After briefly reading any current paper on PNC research, especially those published by the NIST (National Institute of Standards and Technology) particularly those written by Alexander B. Morgan, Jeffery W. Gilman, and Richard H. Harris it is evident that Polymer Nanocomposites, Polymer-Clay Nanocomposites in particular, will soon be the primary source of new advances in polymer research. Since Nanocomposites have shown to have so much potential, and since the key to creating a good Nanocomposite is achieving proper and uniform exfoliation, our main goal for this project is to get good exfoliation between the PS/PMMA and the clay. So far when the two preceding polymers were mechanically blended using the Stony Brook Material Science lab's Brabender blending device they merely became intercalated (i.e. the polymers do not bond on a molecular level as we want them to rather the mixture is ununiform and when analyzed on the Stony Brook Medical Center's TEM [Transmission Electron Microscope] one can see that the polymers do not disperse evenly) however our hypothesis is that we may be able to create an exfoliated Nanocomposite between PS and PMMA by adding clay. Since it has been shown to be the most compatible clay for this type of exfoliation we have been using Cloisite 6A from Southern Clay Company in the polymer blending. What we have in mind is that our findings could be used in industry later on, so every procedure that we do is examined for large-scale practicality before we begin. Our basic procedure has been as follows: we mix different concentrations (%wt.) of clay with the PS and PMMA, mix them for different periods of time at different temperatures and sometimes change the surfactant in the clay. After we have made one of these samples we then analyze them using a UV/VIS Spectrometer, TEM, and Flame test as well as testing for specific heat using a DSC. We have observed that the ideal method for blending these previously immiscible Polymers is to mix them all together at once, we have found that doing so gives both polymers the highest probability to exfoliate with the silicate galleries.

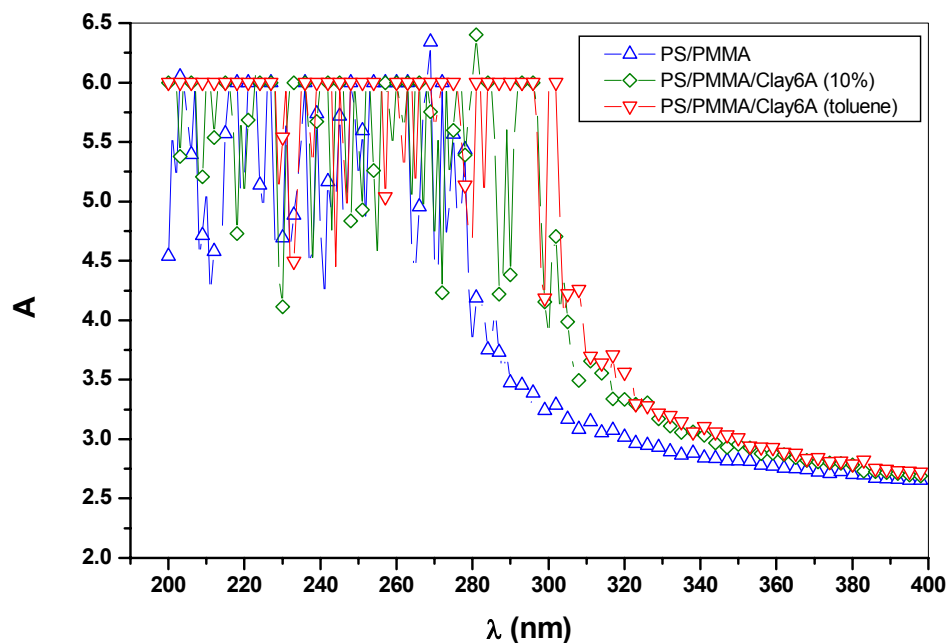

The Effect of Surfaces On DNA Electrophoresis

Vinitha Jacob, Hicksville High School,
Young-Soo Seo, Vladimir A. Samuilov
Department of Materials Science and Engineering, SUNY Stony Brook

Electrophoresis has become the most widely used analytical technique to separate DNA today. Current electrophoretic methods such as gel and capillary electrophoresis use topological constraints in order to separate DNA [1, 2, 3]. It was recently shown that it is possible to separate DNA on a flat Si surface [4]. This process works on the principle that surface friction is responsible for the separation. Meistermann and Tinland [5] have shown that it is possible to separate DNA with 3-D silica matrices. In this research, a novel approach of fabricating 2-D arrays of silica beads (an analogue of the 3-D silica matrices) of different sizes on a flat Si surface is demonstrated and the effect of these surface corrugations on DNA mobility during electrophoresis will be investigated. Another part of this project also looks at the effect of polymer-coated surfaces on DNA electrophoresis. It is found that polymer-coated surfaces help to reduce electroosmotic flow (EOF), which is a force caused by the free flowing ions in solution. The electroosmotic flow sometimes causes DNA to flow in the opposite direction from which it is supposed to. This project will attempt to study whether this reduction in EOF is sustained even after repeated electrophoresis on the polymer-coated surface. A portion of this research will also study the contact angle of DNA as a function of time on these surfaces under an electric field.



(a) Optical Microscope Image of 2 micron silica bead surface

- [1] M.W. McDonell, M.N. Simon, F.W. Studier, *Journal of Molecular Biology* **110**, 119-146 (1977).
- [2] G.W. Slater, T.B.L. Kist, H.J. Ren, G. Drouin, *Electrophoresis* **19**, 1525-1541 (1998)
- [3] J.M. Deutsch and T.L. Madden, *Journal of Chemical Physics* **90**, 2476 (1989).
- [4] N. Pernodet, V. Samuilov, K. Shin, J. Sokolov, M. Rafailovich, D. Gersappe, B. Chu, *PRL* **85**, 5651 (2000).
- [5] L. Meistermann and B. Tinland, *Physical Review E* **62**, 4014 (2000).

Fibronectin Fibrillogenesis on Sulfonated Polystyrene Surfaces

Stephanie Kaszuba, Smithtown High School
Miriam Rafailovich, Nadine Pernodet,
Dept. Material Sciences and Engineering, SUNY Stony Brook

Tissue that keeps joints and bones stable dies naturally all the time in the process of movement and friction. Normally, this tissue can regenerate itself and replace lost tissue through a process known as fibrillogenesis. A protein known as fibronectin recognizes the normal bone or joint recognition sequences and grows a matrix on which tissue cells can grow. If this matrix is not present, tissue will not grow and the bone or joint will not be stable. When one receives a bone or joint implant, these recognition sequences are not present, and the fibronectin cannot produce its matrix on which cells can grow. I have worked to find the optimal surface on which these recognition sequences will be present and will cause fibronectin to grow a matrix for cell growth.

The surface had to be charged and organic so the protein wouldn't reject it, so sulfonated polystyrene was an optimal choice. This was spun on pure, clean silicon. Then the problem developed of what percentage of sulfonation was optimal for the fibronectin. It was determined that 24% sulfonation produced a lattice that was viewable under an atomic force microscope. From previous studies on this topic, I found that if the surface was incubated, at 37°C, for four days, in a solution of fibronectin, a lattice would form. This could be viewed under an atomic force microscope. However, because of this long waste of time I sought to find an amount of time that would be sufficient for incubation. Creating a time dependence experiment and testing the effects of incubation time on lattice size did this.

I also worked with the surface area of the samples. Gratings, which have more surface area, seemed to produce better results than flat silicon. Other surfaces, such as gold and nickel were tested for their ability to produce lattices when sulfonated polystyrene was spun on them, but the results were disappointing. Fibronectin doesn't seem to like metals and wouldn't form a lattice on them. This shows that implants should not be made of these metals due, not only, to their price, but also due to their ineffectiveness. Even gratings of combinations of silicon and metals showed that the lattice only formed on the silicon, leaving holes on the metal parts of the surfaces.

As of right now, implants are not being coated with sulfonated polystyrene, and therefore have a lifespan of about 10 years. One must go for a long and costly operation every ten years to replace their implant or infection will develop. Coating the surfaces with sulfonated polystyrene could greatly increase the lifespan of the implants, reducing overall cost and increasing the benefits of implants.

Fig. 1: Heparin binding cradle

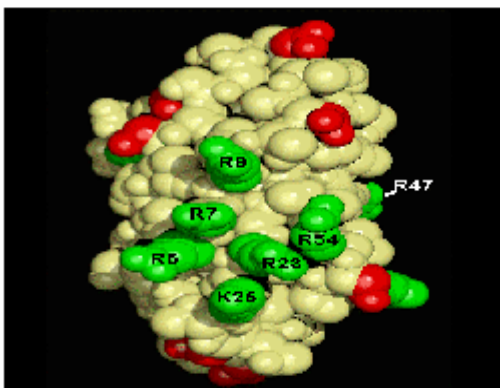
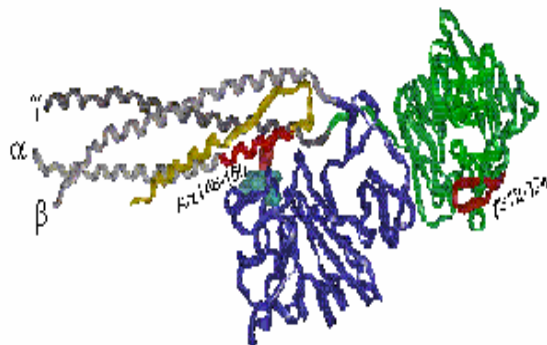

Fig. 2: Structure of fibrinogen



Protein Adsorption on a Di-block Copolymer Nanopattern

Jonathan Katz, Plainview-Old Bethpage JFK High School

Miriam Rafailovich, Shouren Ge, Jim Quinn, Yantian Wang

Department of Materials Science and Engineering, SUNY Stony Brook

Protein adsorption is the process in which a protein adheres to the particles of a certain surface, in this case a patterned polymer surface.¹ The protein that will be used will be fibronectin. It has been seen that the surface morphology affects the surface charge density and therefore plays a role in fibronectin adsorption rate.² While in the past protein adsorption has been done on polymer micropatterns, the nanopatterns that have been created are a thousand times smaller and therefore much more precise. These patterns were made using the process of sputtering, which as done in an ion mill uses gas jets to remove layers of a film. In this case, the di-block copolymer was spun cast onto silicon, and the film was sputtered through to leave just the silicon and patterned remnants of polymer, the nanopattern. Figure 1 shows both the un-sputtered and sputtered surfaces of a 15 mg/mL di-block copolymer film. Figure 2 shows the sputtered and un-sputtered parts of a 30 mg/mL di-block copolymer film. The 15 mg/mL and 30 mg/mL films were approximately 1100 Å and 2500 Å thick, respectively, prior to sputtering. The resultant nanopatterns will be prepared and used for adsorption of the fibronectin.

Figure 1:
AFM
scans-
sputtered
15 mg/mL
di-block
copolymer
film on Si
[top] un-
sputtered
surface
[bottom]

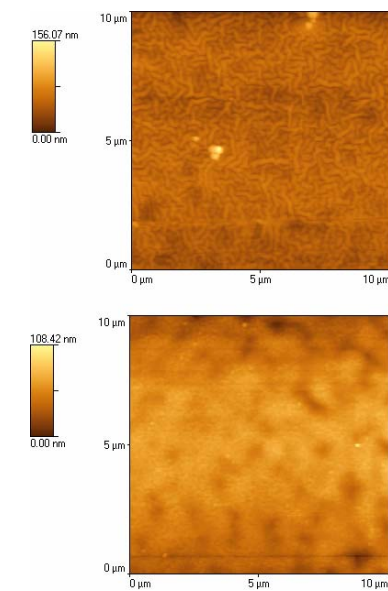
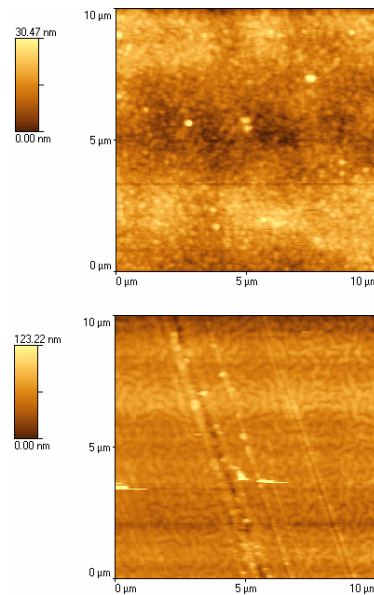

Figure 2:
AFM
scans-
sputtered
30 mg/mL
di-block
copolymer
film on Si
[top]
sputtered
surface



¹ <http://www.iversoftware.com/reference/chemistry/a/adsorption.htm>

² Rafailovich, Miriam, et. al., "Protein Adsorption and Bone Cell Adhesion On Nano-Structured Polymer Surfaces."

DNA Ring From a DNA Drop

Unaza Khan, East Islip High School,
Dina Gewaily, Brown University
Young-Soo Seo, C. V. Krishnan, V. Samuilov, and Miriam Rafailovich,
Dept. of Materials Science and Engineering, SUNY Stony Brook

When a drop of coffee is spilled on a surface, quite often on drying, it leaves a stain in the form of a ring. This phenomenon has received a lot of recent attention. The scientific basis for this observation has been explored by different groups of scientists. Biologically important molecules such as DNA are absorbed on flat silicon wafers for doing DNA electrophoresis. For obtaining perfect drops one has to often investigate hydrophilic, hydrophobic and optimal surfaces.

In this project the evaporation profile was explored for Lambda DNA (bacteriophage lambda, 500 micrograms/mL, molecular mass 3.15×10^6 Daltons, 48,502 base pairs in length, pH 8.0, 10mM Tris-HCl and 1 mM EDTA) droplets. DNA drops were added to silicon wafers. In order to elucidate the importance of surfaces, these wafers are pre-coated with different substrates such as octadecyl trichlorosilane, polystyrene-polymethylmethacrylate blend, and polyvinyl pyridine. Contact angle measurements and mass loss measurements on these samples were made. The formation of a DNA ring on drying of the drop was confirmed using a dye, ethidium bromide, and a confocal microscope. In order to elucidate the influence of electrostatic interactions, measurements were carried out using NaCl, NaBr, and NaI. This should indicate the influence of negatively charged monovalent anions. The influence of monovalent cations was studied using LiCl, NaCl, and KCl. These studies, we hope, will lead us to understand the influence of electrostatic interactions, and substrate-solute interactions on DNA ring formation and DNA droplet morphology.

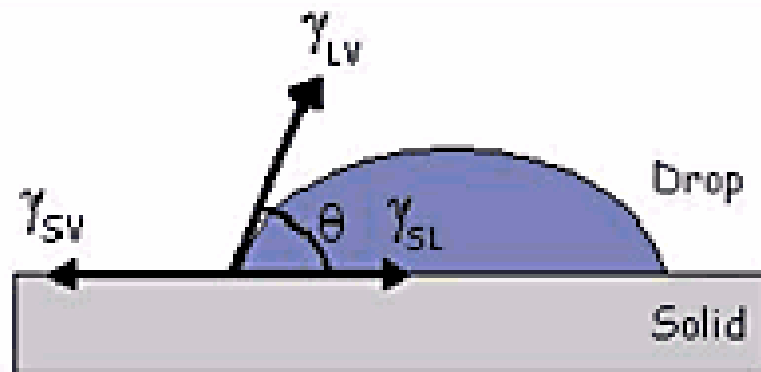

$$\gamma_{LV} \cos \theta = \gamma_{SV} - \gamma_{SL}$$

DNA droplet on Silicon wafer coated with Octadecyltrichlorosilane

Effects of Octa-Methyl-Poss in the Visco-Elastic Response of Polystyrene

Richard Lee, Paul D. Schreiber High School
 Jean Harry Xavier, Miriam Rafailovich, Jonathan Sokolov,
 Department of Materials Science and Engineering, SUNY Stony Brook

Several samples all with different amounts of Octa-Methyl-POSS were mixed by weight percent (.5%, 1%, 2%, 3%, 4%, 5%) with monodisperse polystyrene to control the mechanical properties of free standing polystyrene films. The surface of the films and the effects of Octa-Methyl-POSS in the glass transition temperature (T_g) of polystyrene were studied using Atomic Force Microscopy (AFM) and Shear Modulation Force Microscopy (SMFM). In order to measure the visco-elastic response of the film, we nucleated a 100 micron size hole and observed its rate of growth as a function of temperature while annealing in a vacuum of 10^{-7} Torr. For film of 3750A thick, the hole velocity is linear at $T \leq 120^\circ\text{C}$ and exponential at $T \geq 130^\circ\text{C}$. We observed also a phase transition Linear-Exponential at $T=125^\circ\text{C}$. The time flow of the experiment increased monotonically with Octa-Methyl-Poss concentration. Results were compared with other filler particles such as colloidal gold, palladium, and 6A exfoliated clay.

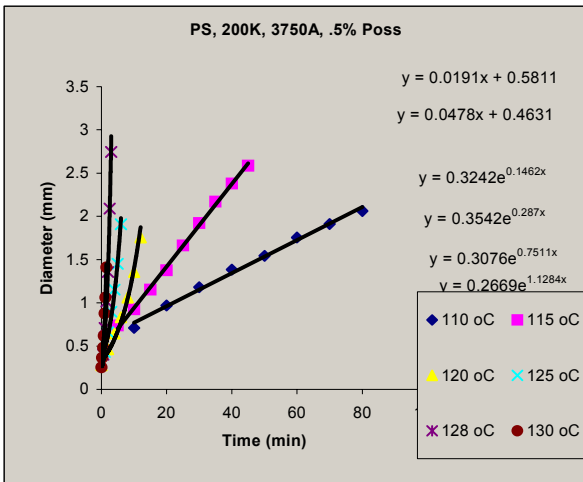

With .5% POSS

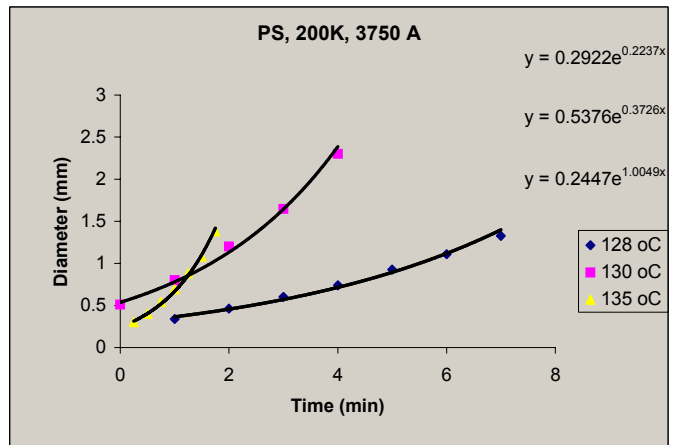

Without POSS

Making Giant Magnetoresistant Devices Using Nano-Patterning Methods

Lisa Marx, **Jericho High School**

Richard Gambino, Miriam Rafailovich, Yan-tien Wang,
Department of Material Science and Engineering, SUNY Stony Brook

With new technologies being developed, everything is becoming smaller. Firearms are being reduced in size to the point where the metal detectors of today cannot detect them properly. The use of giant magnetoresistant islands in metal detectors will increase sensitivity to metals and result in increased efficiency in detectors.

Giant magnetoresistant behavior (GMR) is exhibited when magnetic islands are present in a conductive matrix. To achieve this, a layer of copper $\sim 20\text{-}50\text{\AA}$ (angstroms) thick is deposited on a silicon wafer using an ion beam assisted deposition (IBAD) system. Above the copper, a layer of cobalt $\sim 50\text{-}100\text{\AA}$ is deposited, once again, using the IBAD system. Next, a blend of polymers (polystyrene and polymethyl-methacrylate) is spun cast on the sample. The sample is then annealed at 170°C for four days. Annealing the sample allows the polymers to separate and form islands on top of the metal substrate. The polymeric islands serve as a template for the magnetoresistant islands. The sample is then placed in an ion mill, where the polymer and parts of the metal substrate are sputtered off with Argon ions. What is left on the silicon wafer is a pattern of Co islands, $\sim 50\text{-}100\text{\AA}$ thick. At this height GMR behavior is the greatest. Finally, another layer of copper approximately the same thickness as the first is deposited.

To test for GMR, a four-point probe is used. The four-point probe detects changes in resistivity when constant voltage and current is applied. If the islands exhibit GMR behavior, a drastic change in resistivity is observed. Changes in resistivity are due to the spin of the electrons in the layers of Cu and Co. When a magnetic field passes through a GMR device, the spins of the electrons in the device align. Alignment of the spins is what causes the change in resistivity. This change in resistivity is seen when a metal object passes through a metal detector with GMR islands.

$$\Delta\rho/\rho = (\rho_{\max} - \rho_{\min})/\rho_{\min} = (R_{\max} - R_{\min})/R_{\min}$$

Where ρ_{\max} = maximum resistivity at zero applied field

ρ_{\min} = minimum resistivity at saturation

R_{\max} = maximum value of measured resistance

R_{\min} = minimum value of measured resistance

(Jhon Tabares. Fabrication and Characterization of Giant Magnetoresistant Island Structures, State University of Stony Brook. December 2000. p 13-14)

This equation is used to measure change in resistance. Samples with GMR behavior usually have a high ratio of $\Delta\rho/\rho$, however, it is more important to see a drastic change in resistance at low applied fields for practical application in metal detectors. It is expected that the samples created will exhibit GMR behavior because they have all of the characteristics of a GMR material.

Properties of ICP-type Polymer Thin Films (PANI and PPE) And the Oxidation of Copper and Aluminum Substrates

Aprajita Mattoo, Jericho High School, James Cruise III, Plainview High School,
Jessica Rouge, Sachem High School, Peter Spellane, Life Sciences Secondary School,
Miriam Rafailovich, SUNY Stony Brook

Metal corrosion presents a major problem to all aspects of industry. Thin polymer films applied to metal surfaces may create a chemical barrier against corrosion and would, therefore, prove very useful for future industrial development. Copper (Cu) and Aluminum (Al) were coated onto Silicon (Si) wafers by vapor deposition to a thickness of $\sim 1000\text{\AA}$. The wafers were cut into $\sim 1\text{cm}$ squares and placed into Reactive Ion Etch in order to remove their oxide layer. The clean metal surfaces were then spun casted with 1% solutions of Polyaniline (PANI) and Polyphenylene Ether (PPE). The samples were first observed with the Optical Microscope to check for wetting patterns. They were later scanned with the Atomic Force Microscope in order to verify polymer wetting and a flat surface topography. The wafers were then taken to the National Synchrotron Light Source at Brookhaven National Laboratory where they were analyzed using X-ray reflectivity.

The research was expanded into the field of polymer conductivity. Si wafers were spun casted with PPE solutions of varying concentrations (0.5%, 1%, and 2%). Conductivity of the thin films was tested using a Four Point Probe in order to determine the correlation between film thickness and conductivity.

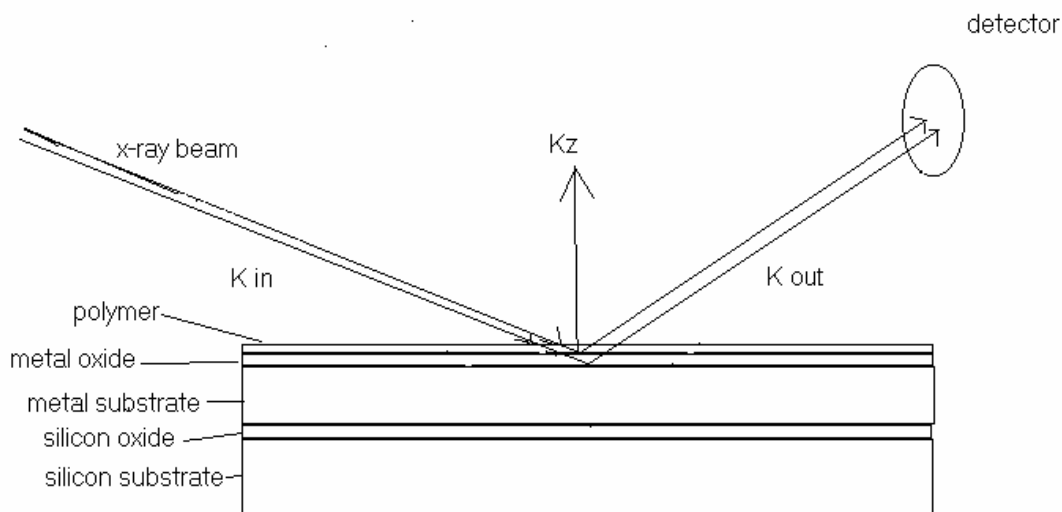

Compatibilization of Polycarbonate and Styrene Acrylonitrile-17 Using Clay

Varun Mehta, Sachem High School
C. V. Krishnan, and Miriam Rafailovich,
Department of Materials Science and Engineering SUNY Stony Brook

Polycarbonate is a hydrophilic polymer. Varying the acrylonitrile content can change the hydrophilic nature of polystyrene acrylonitrile. To improve the quality of polymers, considerable attention has been devoted recently to mixtures of polymers with and without added material such as clay, and various types of fillers.

In the present project polycarbonate (PC) and polystyrene with 17% acrylonitrile (SAN-17) were chosen to investigate their compatibility. First their solubility in different solvents was investigated. It was found they are most soluble in methylene chloride and chloroform. All further measurements were made using methylene chloride as the solvent. The polymer concentration was about 50mg/mL.

Hydrophobic clays such as Cloisite 6A, Cloisite 15A, and Cloisite 20A (in decreasing order of hydrophobicity) and hydrophilic clays such as Lucentite SWN and Samosif were mixed with PC and SAN-17 mixtures (0, 25, 50, 75, and 100% PC). About 5% Clay was used for these studies, and a control with no clay. The mixtures were sonicated for 4 hours before spin casting on hydrophilic silicon wafers at 2500 RPM and annealing in vacuum at 170°C for 24 hours.

Topographical and friction measurements using Atomic Force Microscopy were performed on the samples. The data will be analyzed to determine the best composition of polymer mixture, and the best clay for optimum compatibility. Future work will include instron testing, brabending, and molding blends in a hot press to confirm the compatibility.

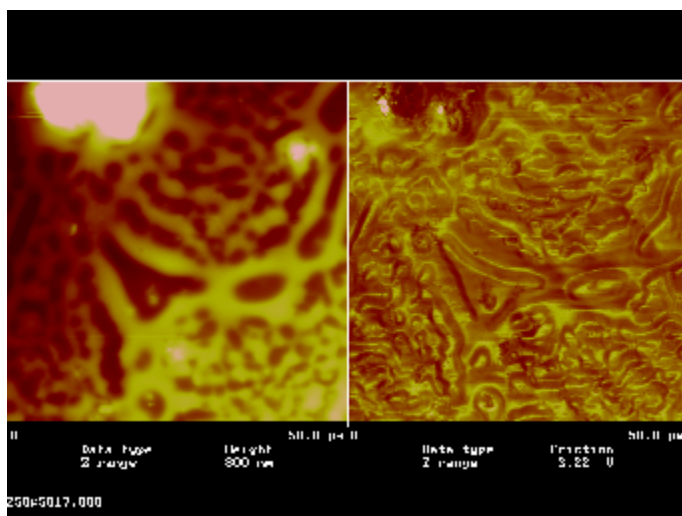

50% Polycarbonate and 50% Styrene Acrylonitrile-17 with 5% Cloisite 20A

Improving the Properties of Polymer Blends with Supercritical Carbon Dioxide

Edmund Palermo, Bay Shore High School, Ronald Occhiogrosso, HAFTR

Abstract:

Improving the properties of polymer blends is of technological interest because of the commercial and industrial benefits involved. Ethylene vinyl acrylate (EVA) and polystyrene (PS) were blended in this study and exposed to Supercritical CO₂. Ultra-thin films were spun cast on Silicon to study molecular compatibility and large bulk samples were also mixed to study mechanical properties. Atomic Force Microscopy (AFM), Differential Scanning Calorimetry (DSC), and Instron tensile tests were used to measure the topography, melting points & glass transition points, and tensile strength of the samples before and after exposure. On the molecular level, the compatibility between EVA and PS was improved as per the AFM data, which showed generally smoother topography in samples exposed to SC CO₂. Such improved compatibility served to improve the ductility of larger bulk samples, as supported by the Instron data.

Experimental Setup: Supercritical CO₂ Unit under controlled Temperature & Pressure

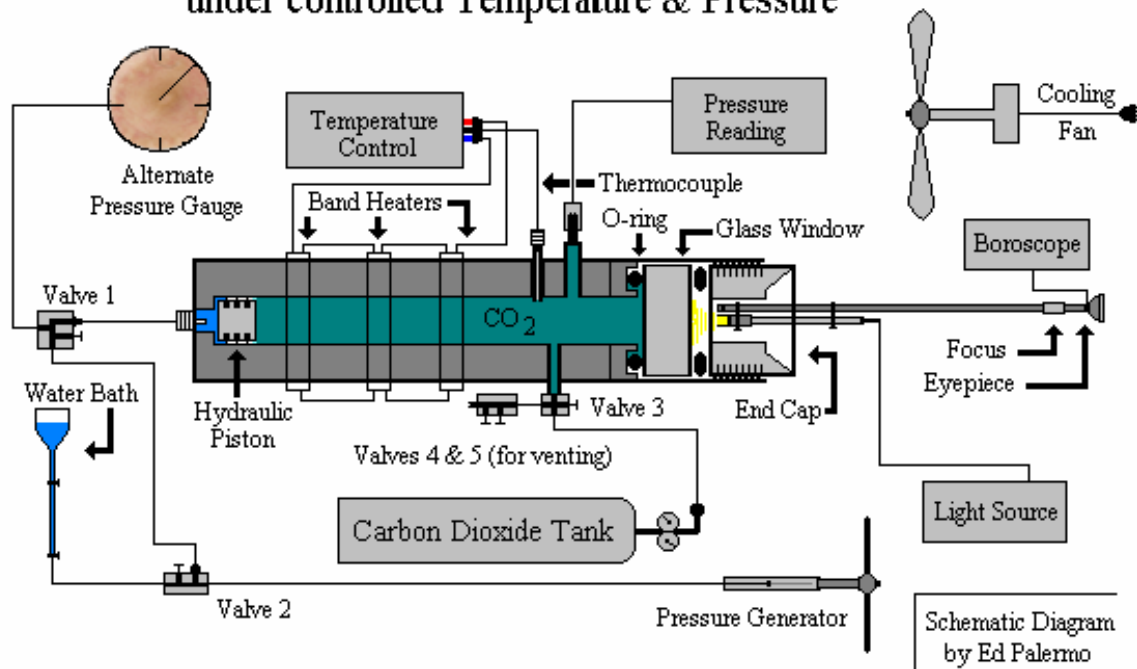

Diffusion Dynamics in Free-Standing Polymer Thin Films

Eric Petersen, Ward Melville High School
Song Feng Li, Jonathon Sokolov, SUNY Stony Brook

I have studied the diffusion dynamics in free-standing polymer thin films. I studied the diffusion rate in free-standing thin films to that of supported thin films. Previously, diffusion rates have been studied using pure polymer. In my research, I added nanoparticles, such as clay, to the polymer thin-films and observed the effect these particles had on the rate of diffusion. In order to study diffusion, I prepared samples with two or three polymer thin-films on top of a Silicon substrate. These samples were prepared by spin casting a polymer solution onto a glass slide. Then the film was floated off the glass in distilled water, the picked with Silicon, or another film. The samples were then annealed at 120° C for three hours in a high vacuum annealing oven. The diffusion would take place while annealing. After the samples were removed from the oven, there were analyzed using a Secondary Ion Mass Spectrometer.

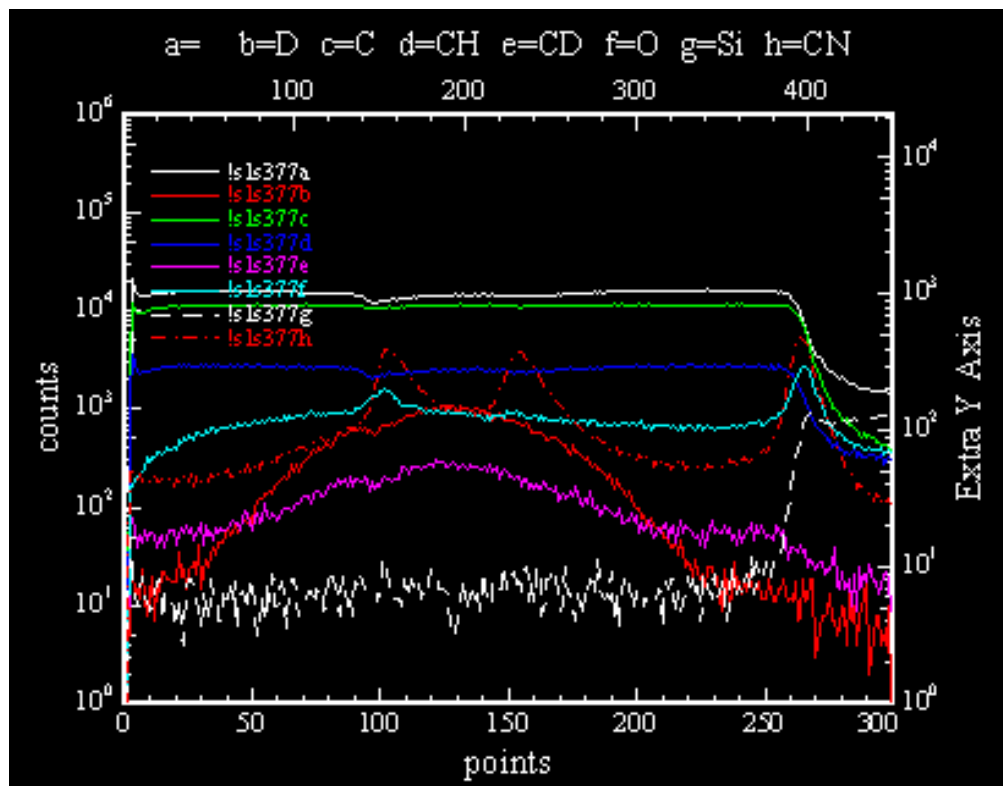

PS-PMMA Blends with POSS-PMMA Nanocomposite Polymer

Luis Rodriguez, Roosevelt High School, Yonkers, NY

Miriam Rafailovich, Department of Material Science, SUNY Stony Brook

Polyhedral oligomeric silsesquioxane (POSS) is a material with the capacity to improve the properties of other polymers. The use of POSS in some polymers results in enhancement of the physical properties of the compositions.

Typical characteristics are, enhanced fire retardation, higher use temperature, lightweight, increases modulus and hardness, etc. The improvement of certain polymers by adding POSS can be successful, but is important to understand how it blends with other polymers. In this case I attempted to analyze the properties of PS-PMMA (Polystyrene – Polymethyl methacrylate) blends with POSS-PMMA.

Procedure: I made a PS-PMMA solution, with a concentration of 20 mg/ml, using toluene as solvent. I distributed the solution in four recipients and I added different amounts of POSS 15% (POSS-PMMA), 5%, 10%, 15%, and 20%. I spun each of the solutions in clean Si wafers at 25k RPM for 30 sec., and I annealed them for 24 hrs at 170C in order to determine the equilibrium configurations. The films were analyzed using Atomic Force Microscopy (AFM).

Results: The AFM results show that the PS phase is spread on the Si wafer and the POSS-PMMA is spread over the PS making little elevations. Based on these results, it appears that the addition of small amounts of POSS to the PS-PMMA can affect significantly their properties. The pictures from the AFM of the films have shown that PS-PMMA blends very well with small amounts of POSS-PMMA, but in some cases (large amounts), a line between the phases can be distinguish. One of the observations that I noticed was that the surface is not completely flat; the pictures show higher islands on the surface.

Properties of Thin Film ICP-type Polymer (PANI-EB and PPE) Coatings and the Oxidation of Aluminum and Copper Substrates

Jessica Rouge, Sachem High School, James Cruise, Plainview High School, Apra Mattoo, Jericho High School, Peter Spellane, Life Sciences Secondary School

Metal corrosion is extremely costly to industry. Inherently conductive polymer (ICP) coatings on metal substrates may provide effective chemical protection against the corrosion of metals. The interface of ICP coatings with aluminum and copper - two important industrial metals - was examined. Cu and Al were vapor deposited on silicon wafers (~1 in²). Prior to the application of the polymers, the metal surfaces were treated with Reactive Ion Etch (RIE). Etching the metals removes the top layer of oxide from the metals, making the metal surface more conducive to the application of the polymer coatings. The polymers Polyaniline (PANI-EB) and Polyphenylene Ether (PPE) were spun coat onto the metal surfaces. The coated samples were then analyzed by X-ray reflectivity* so that the thickness of the metals' oxide could be determined. Thickness of the polymers on the metal oxides was calculated using ellipsometry techniques. The correlation between the oxide thickness and the presence of the PANI-EB and PPE coatings was then carefully analyzed. Especially significant was the different behavior of PANI-EB and PPE as coating material. A second aspect of the research was on the conductive properties of PANI-EB and PPE on silicon wafers. Conductive polymers in a thin film on Si substrate would have numerous industrial applications. To test for conductivity of the polymers, a four-point probe was used. The coatings were viewed under an optical microscope to check for evidence of a wetting pattern. Analysis of the coatings themselves was obtained using Atomic Force Microscopy (AFM). The AFM showed the topography of the polymer films to be extremely smooth. Therefore the polymer coatings uniformly wet the surface of the metals. The results of the metal oxide-polymer interfaces are yet to be determined as well as the conductivity experimentation. More conclusive results will be available within the next week or two.

* X-ray reflectivity testing was performed at beamline X10B at the National Synchrotron Light Source at Brookhaven National Laboratories, Upton, NY .

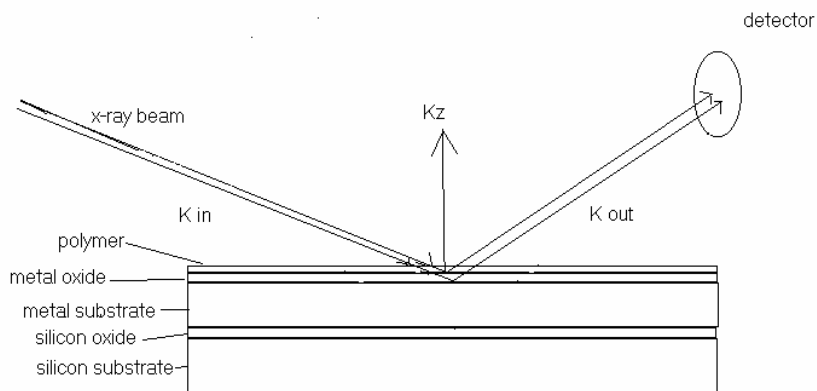

The Effect of the Chemical Addition of POSS on Compatibilization Based on Chemical Attachment

Eric Schrag, *University of Delaware*
Miriam Rafailovich, *SUNY at Stony Brook*

The purpose of this study was to compare the power of Cyclopentyl Polyhedral Oligomeric Silesquioxane (POSS) as a compatibilizer of Polystyrene (PS) and Polymethyl Methacrylate (PMMA) dependent upon its chemical attachment to the polymer PMMA. The study was performed by making 50-50 mix solutions of PS and PMMA, either with PMMA-POSS (chemically joined POSS) or free-floating POSS in the solution. These solutions were made using 5% and 10% POSS (by weight), spun into films, and compared both with each other and with a baseline 50-50 thin film of PS and PMMA. Atomic Force Microscopy was then performed upon the thin film samples in order to compare dewetting and compatibilization. Each sample was then annealed in vacuum at 170°C for 72 hours in order to simulate the passage of time, and the samples were studied using Atomic Force Microscopy again.

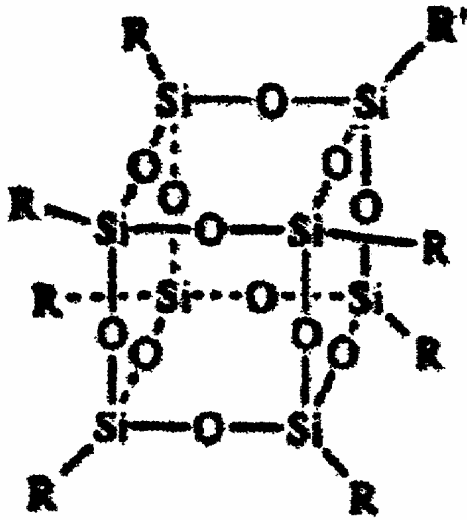

Figure 1 - Chemical Structure of POSS

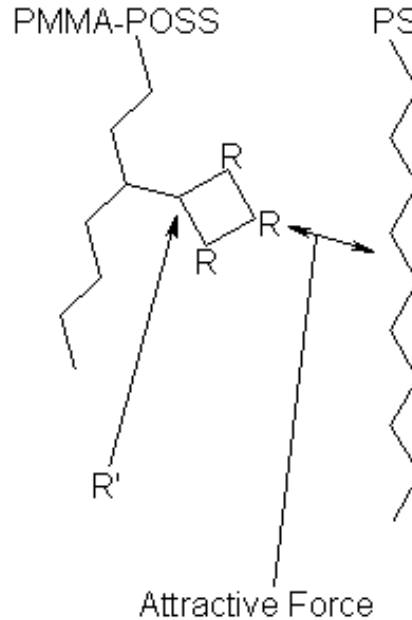

Figure 2 - PMMA-POSS and PS Interaction

The Effects of Fillers on Adhesion at Polymer Interfaces

Anshul Shah, Ward Melville High School / Harvard University

Mordechai Bronner, Rambam Mesivta High School

Miriam Rafailovich, SUNY Stony Brook, Dept. of Materials Science and Engineering,

We investigated the impact of two fillers, carbon black and colloidal silica, on the adhesion at interfaces of polystyrene (PS) and polymethyl methacrylate (PMMA). The fillers' effects on bulk properties of polymers have been reported in previous literature. Carbon black is added to tires to improve the mechanical properties of the rubber and to provide thermal stability. The more expensive silica is used in higher-end tires, because it reduces rolling resistance. A recent problem has been the failure of tires due to tread separation, a result of adhesive failure at the tread's interfaces with other rubber components. Since this adhesion is normally strong in the pure polymers, we theorized that carbon black could be responsible for the poor adhesion in tires. Solutions containing PS and varying concentrations of carbon black were spun-cast onto compression-molded PS slabs, coating the slab with a thin film of polymer and carbon black. Each coated slab was then joined with another slab in a hot press at 150°C, allowing adhesive bonds to form. The joined samples could then be tested via the Asymmetric Double Cantilever Beam (ADCB) device, which propagates a crack at the interface. Measurement of the crack length allows for calculation of the fracture toughness, a value that quantifies adhesion. The procedure was repeated with PMMA. Also, three different types of N299 carbon black, obtained from Cabot Corp., were tested: untreated (standard), heat-treated at 1100°C, and heat-treated at 2400°C. The results showed that the fracture toughness of PS/PS and PMMA/PMMA interfaces declined significantly as increasing concentrations of carbon black were added. However, the heat-treated grades, especially the one treated at 2400°C, did not exhibit quite as drastic an effect. Hence carbon black, while able to improve various bulk properties of polymers, can lower the adhesion at polymer interfaces, although treating the particles appears to reduce this effect. The addition of colloidal silica to the PS/PS interface had a similar but smaller effect; however, when even a tiny content of silica was present, the further addition of large amounts of carbon black had almost no impact. Carbon black particles can hinder adhesion by interacting with polymer chains, thereby blocking diffusion. Colloidal silica particles, in contrast, are coated with a non-interactive surfactant and do not react; when silica and carbon black are mixed, the surfactant affects both fillers. This use of silica to offset the interactions of carbon black can be important for the tire industry. Future work will utilize Atomic Force Microscopy (AFM) to examine cracked interfaces and determine the mechanism of adhesive failure. Secondary Ion Mass Spectroscopy (SIMS) will be used to measure interfacial diffusion, a quantity that is directly related to adhesion. Also, X-ray diffraction will indicate whether heat-treated carbon black particles are more effective due to a crystalline structure.

Fracture Toughness of PS/PS with Carbon Black at the Interface

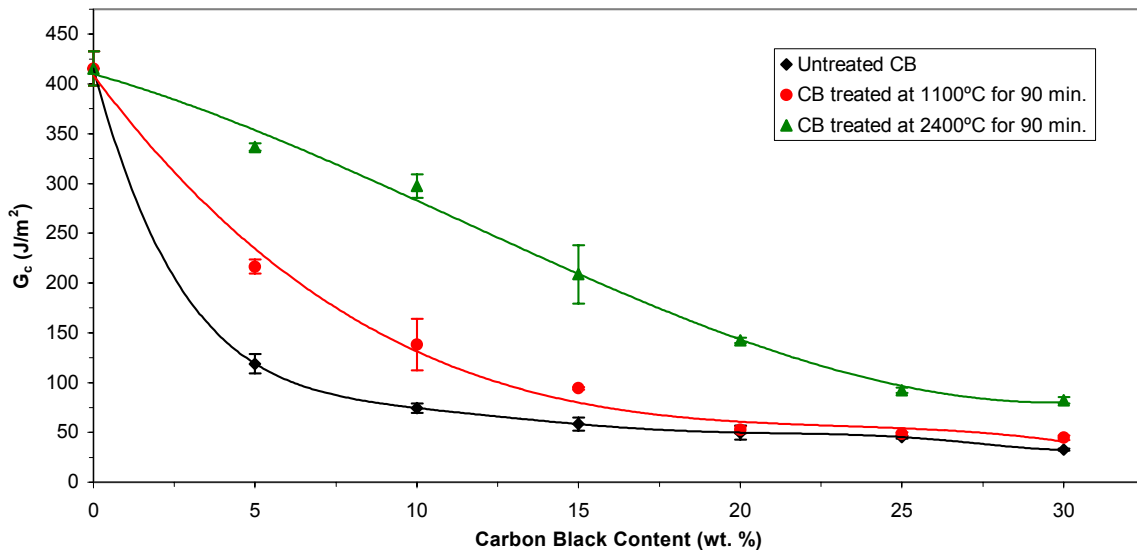

Fluid Flow From a DNA Drop

Jessica Slack, East Islip High School;

Dina Gewaily, Brown University

Young-Soo Seo, C. V. Krishnan, V. Samuilov, and Miriam Rafailovich,
Department of Materials Science and Engineering, University at Stony Brook

Fluid flow in an evaporating droplet has received considerable recent attention. Quite often solutes from a drying drop form a ring. The absorption characteristics of biologically important molecules such as DNA on flat silicon wafers have been utilized recently for doing DNA electrophoresis. Hydrophilic, hydrophobic and optimal surfaces have been explored for obtaining perfect drops on a surface. The present project is an extension of some of those studies.

In this project the evaporation profile of Lambda DNA (bacteriophage lambda, 500 micrograms/mL, molecular mass 3.15×10^6 Daltons, 48,502 base pairs in length, pH 8.0, 10mM Tris-HCl and 1 mM EDTA) droplets from silicon wafers coated with different substrates such as octadecyl trichlorosilane, polystyrene-polymethylmethacrylate blend, and polyvinyl pyridine was explored. Contact angle measurements, mass loss measurements and ring formation with added ethidium bromide were carried out using DNA in tris buffer in the presence and absence of salts such LiCl, NaCl, NaBr, NaI, and KCl. From these studies we hope to arrive at definite conclusions on DNA ring formation, DNA droplet morphology, and evaporation. We also hope to extract information regarding electrostatic effects, and substrate-solute interactions.

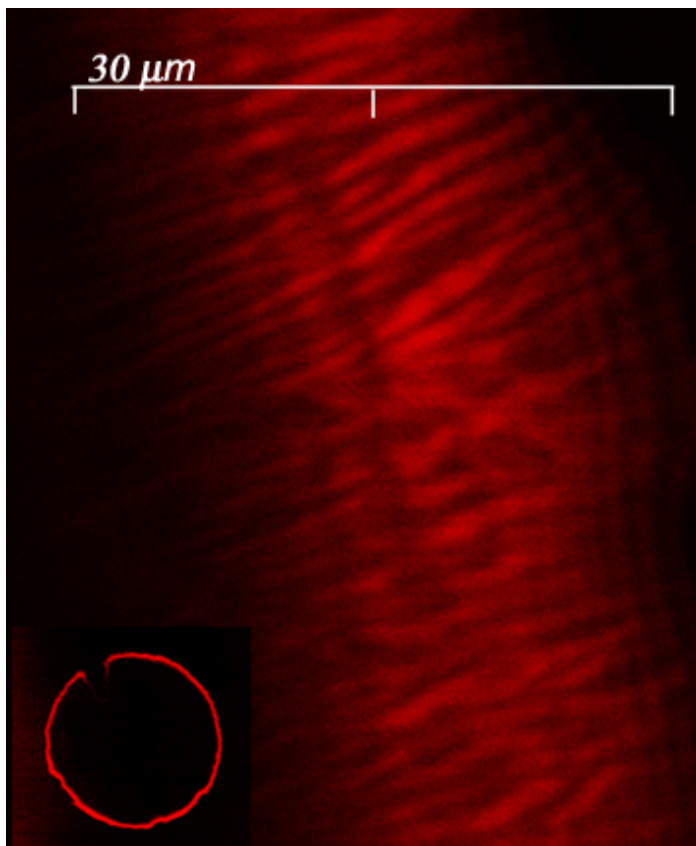

Dried DNA droplet on silicon wafer coated with Octadecyl trichlorosilane under confocal microscope. Ring width is about 30 micrometers.

Melt Fracture as a Function of Molecular Weight

Dora Sosnowik, Shira Billet, Stella K. Abraham High School,
Sarika Sharma, Prof. M. Rafailovich, SUNY Stony Brook

It is a scientific fact that the polymers, polystyrene and polymethyl methacrylate have a high interfacial energy. For this reason, when a thin film of one is floated onto the other, dewetting occurs. Dewetting is a natural phenomenon, where holes form in layers of a bilayer with a high interfacial energy. The end result of dewetting is one of the thin films beading up into isolated droplets, making the polymer cover as little of the other polymer's surface as possible. Another natural phenomenon in the field of dewetting is melt fracture. Melt fracture is when the holes of dewetting form through both thin films. Our hypothesis as to the cause of melt fracture was that it is dependant on the molecular weight of the lower layer polymer. We proposed that low molecular weights would remain as a liquid substrate, and the higher ones would solidify. We then suggested that in the lower molecular weights, the polymers would become entangled at the interface, making any hole forming in one form in the other as well. In our experiment, we floated PS onto PMMA because PMMA has a lower interfacial energy with the silicon wafer than the PS. We chose many molecular weights of PMMA (2K, 4K, 27K, 58K, 78K, and 255K) and spun them all to a thickness of about 1500 angstroms. We then floated 900K PS onto all of our substrates. We guessed that melt fracture would occur only in the samples with PMMA of about 20-50 K. Our reasoning was that anything lower, would not be viscous enough to split, and anything higher, would be a solid substrate. After annealing our samples in a vacuum oven for 20 minutes, we looked at them under the optical microscope and found that the lower molecular weight samples had begun to dewet. To prove that melt fracture had occurred, we used cyclohexane, a solvent that will dissolve PS and not PMMA. After dissolving the upper layer, we analyzed the lower layer to look for holes that may have formed through both layers. If holes did form in the bottom layer, it was proof that melt fracture had occurred.

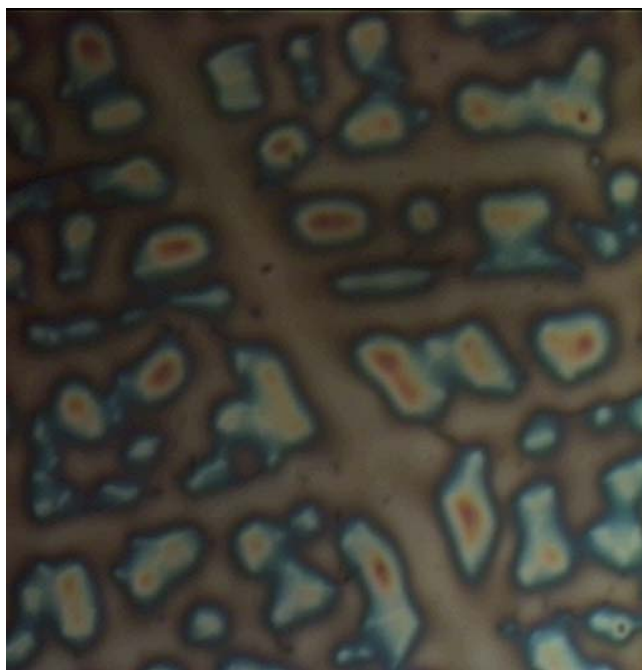

The Effect Of Clay On The Compatibilization Of Polystyrene and Poly(Methyl Methacrylate) Thin Film

Ying Sun, Ward Melville High School

Wenhua Zhang, M. Rafailovich, Xuesong Hu, SUNY, Stony Brook

Previous studies have shown that clay had an effect on improving the compatibilization of Polystyrene and Poly(methyl methacrylate) [1-3]. To explore further on the way clay nanoparticles work in PS/PMMA blend, experiments involving different ratios and different molecular weights of PS and PMMA were performed. Exfoliated clays (Cloisite 6A and 10A) were introduced to PS/PMMA polymer blends to study the effect of phase behavior. A variety of complementary imaging methods such as Scanning Force Microscopy, Secondary Ion Mass Spectrometer, and Transmission Electron Microscopy were used. TEM pictures showed fully exfoliated clay in the blend. AFM pictures showed that in the absence of clay, the annealed spun cast films were phase segregated, and micron size of domains were observed. The addition of both Cloisite 6A and 10A improved the blending and the domains were observed to shrink significantly, especially in lower molecular weight polymers (see fig.) and more percentage of PS. Hence clay increased the compatibilization of PS and PMMA. Cloisite 6A was also put in PS-PMMA diblock solution, and spun cast into thin films. AFM topographical pictures showed that the maze pattern of diblock thin film was flattened by the introduction of clay. The effect of clay on the diffusion of PS and PMMA blend was also studied using SIMS, as well as the effect of clay on PS-PMMA diblock thin film. In conclusion, exfoliated clay can be potential compatibilizers for general polymer blend systems. In the future the effect of filler aspect ratio on polymer blend compatibilization should be studied as well as the equilibrium conformation and dynamics.

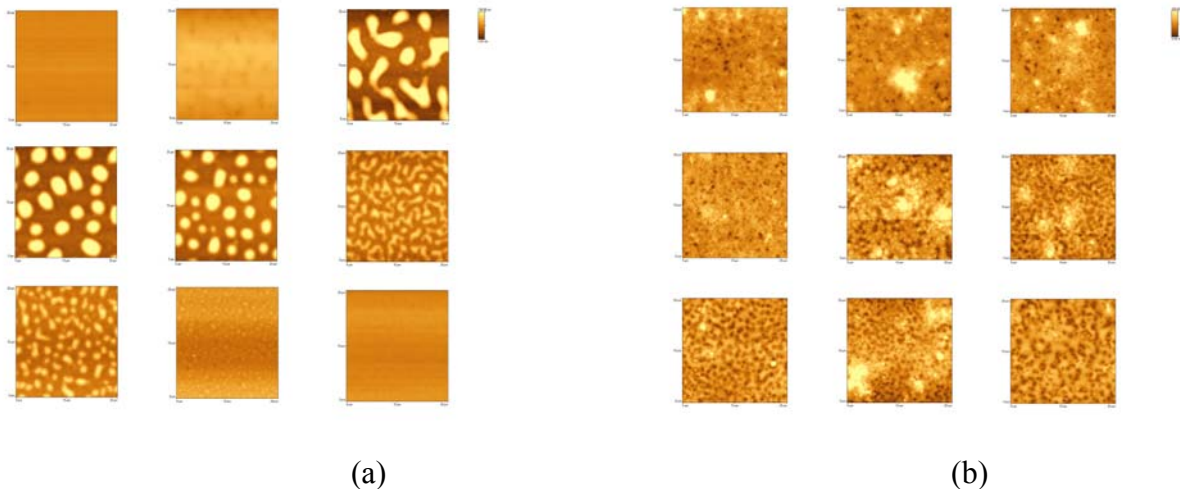

Figure 1. In each of the $20\mu\text{m}\times 20\mu\text{m}$ AFM topographical picture above, from top left to lower right, ratio of PS to PMMA changes from 90:10 to 10:90, the amount of PMMA increases by 10% each time. (a) PS/PMMA thin films without clay added. (b) In each thin film, there is 10% by weight of Cloisite 6a added.

Reference:

1. Rafailovich, Miriam. *Control of Polymer Blend Morphology and Rheology Using Nanoparticles*, 2001.
2. Vaia, Richard A. & Emmanuel P. Giannelis. *Polymer Nanocomposites: Status and Opportunities*, Material Research Society Bulletin, May 2001.
3. Cheung, Grace. *The Compatibilization of Polymer Blends in Clay Nanocomposites*, 2000.

Polystyrene and Polymethylmethacrylate Organoclay Nanocomposites

Vivek Vasudevan, Wheatley High School, Michael Goldman, Rambam Mesivta High School
Mayu Si, Miriam Rafailovich, SUNY Stony Brook

Research has shown that polymers have a low degree of attraction towards each other. The goal of this experiment was to achieve compatibilization of two immiscible polymers known as polystyrene(PS) and polymethylmethacrylate (PMMA). It is hypothesized that organoclays will help create an affinity towards these immiscible polymers by creating a polymer organoclay nanocomposite. Polymer organoclay nanocomposites are a reinforcement of polymers into layered silicates. Polymer nanocomposites are attractive because of their low cost, impact resistance, flame retardants, and other versatile properties. To achieve polymer nanocomposites, it is necessary to have good exfoliation. Thus the main objective was to create proper exfoliation of PS/PMMA with clay. Currently, PS/PMMA and clay have been mechanically blended using the C.W. Brabender. The procedure for creating polymer nanocomposites are by mixing PS/PMMA/Clay using a 45%:45%:10% weight mixture into the Brabender. Then, polymers crawl through the interlayer space to form an intercalated or exfoliated nanocomposite. This process takes 10-20 minutes. Different surfactants, period of time, and specific order of blending the polymers will also be tested to see if proper exfoliation occurs. Presently, these blends have been merely intercalated instead of delaminated(a process when exfoliation occurs where the polymer matrix are dispersed evenly).After the blends have been prepared, the mechanical properties are tested using the UV/VIS Spectrometer, TEM(Transmission Electron Microscope), DSC, and flame tests. These tools will help define whether the polymer nanocomposites are exfoliated, resistant to uv-rays, observe differences in glass transition temperature(Tg)and specific heat ,and to see whether the polymer nanocomposites are flame retardant. It has been observed that the best procedure to achieve proper exfoliation of PS/PMMA and clay is through mixing all three components together at once, rather than mixing them in different orders.

TEM Images of PMMA+PS+CLAY (45/45/10wt%)

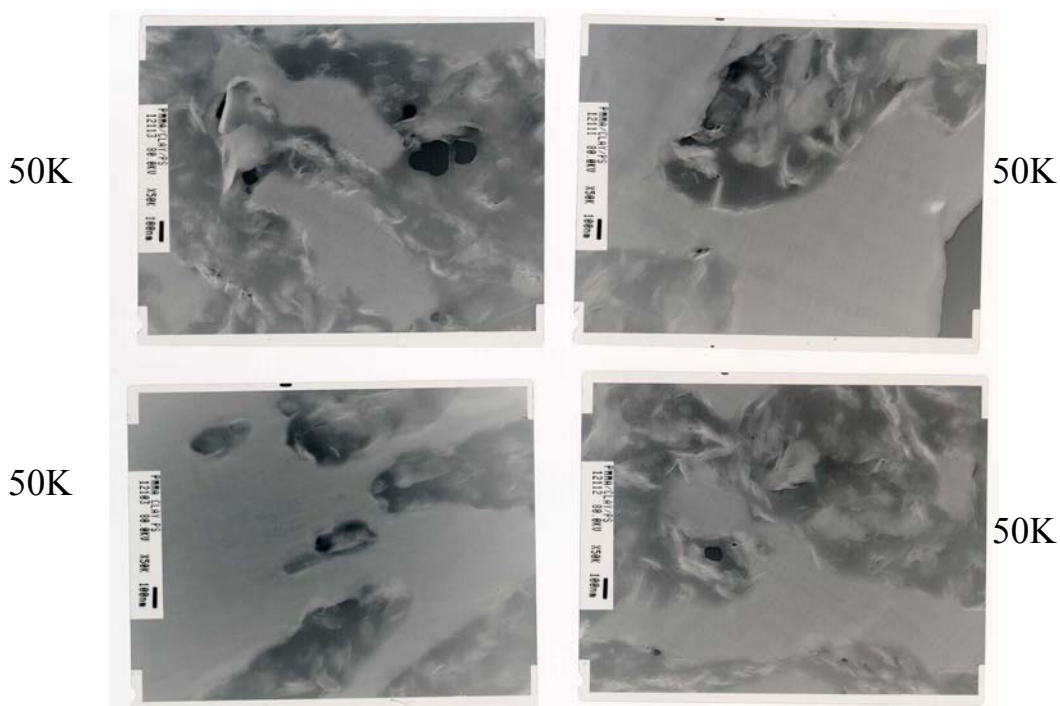

Self-Assembling Nanoparticle At The Air/Water Interface

I. Wong¹, Y.-S. Seo¹, K.W. Shin², V.A. Samuilov¹, J. Sokolov¹, M. Rafailovich¹, A. Ulman³

¹Department of Materials Science and Engineering, SUNY at Stony Brook

²NCNR, NIST

³Dept. of Chemical Engineering Chemistry and Materials Science, Polytechnic University

We report on X-ray reflectivity and TEM studies of nano-particle self-assembly at the air/water interface. Thiol functionalized spherical Pd particles (~3 nm in diameter) were found to form highly ordered lattices. The phase diagram showed a large plateau region where the self assembly is shown to occur. A novel sonochemistry method was used to functionalize nanotube (WS₂). The sonication procedure provides uniform tubes approximately 9 nm in diameter and 100 nm in length. The surface pressure-area diagram also shows a strong plateau which is interpreted as being due to self-assembly. The electric properties of these films which correlate to their structures will be discussed. This work is supported by NSF-MRSEC program.

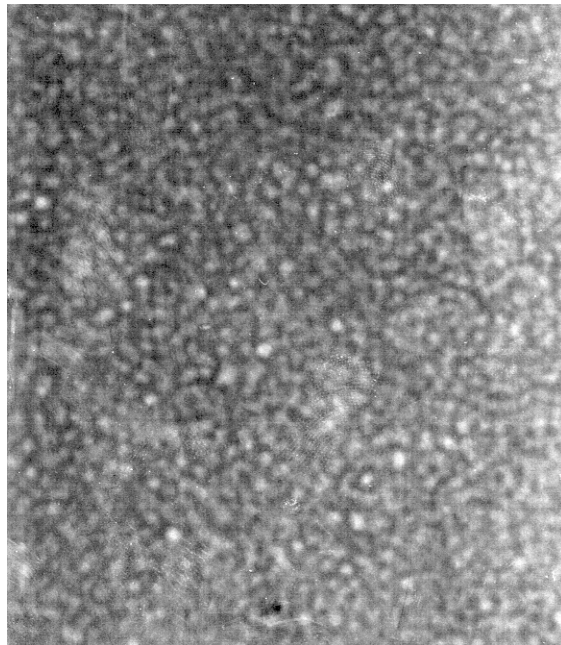

TEM image of a self-assembled highly ordered Palladium monolayer film.

Molecular Computing with DNA Chips and Nanotube Transistors

Felicia Yen, Half Hollow Hills High School, Miriam Rafailovich, SUNY Stony Brook

Material scientists have been searching for new chemicals to replace silicon as memory chips in the computers as early as the 1970s. Making a smaller chip, eventually down to a molecular size, was not possible with silicon. Conventional silicon computer chips are quickly approaching their limits of miniaturization and speed. It has always been a desirable goal among computer scientists and engineers to continuously shrink the computer circuitry to a microscopic level. Until recently, making smaller and faster personal computer using molecular-sized electronic devices, while wiring with a few molecules capable of carrying out logic and memory functions, has been just a pipe dream due to the lack of key technologies and materials. A new alternative way is being developed to accomplish that goal. In recent years, research and development in DNA and nanotubes have found important features as new materials for the future computing chips. DNA molecules offer a further option as oppose to traditional silicon chips. The DNA computation offers some distinct advantages. These microscopic chips are proven to be faster and more energy efficient. They provide a powerful search function, thus, are more capable in finding possible solutions. They are able to process larger jobs quicker and store much more information than today's supercomputer. The DNA processors use readily available biomaterials, yet more cost-effective, making them even more attractive.

Research and development in the nanotube chip field have made impressive progress in making new nanotubes with semiconductor properties and connecting them into more complex circuits. Nanotubes can behave like semiconductor, carrying electricity only above a specific voltage. These molecular conductive and semi-conductive materials are exactly what are needed for creating electronic circuitry in the microscopic space. Several research teams have created devices made from different nanotubes resembled transistors, acting like arrays of electronic circuits. By making devices from small groups of molecules, nanotube chip computers can pack billions of transistors that is more than 30 times the current technology can achieve. In theory one can store a terabit of memory in a square centimeter. At that density, the whole contents of the Library of Congress could be stored in a computer the size of a sugar cube.

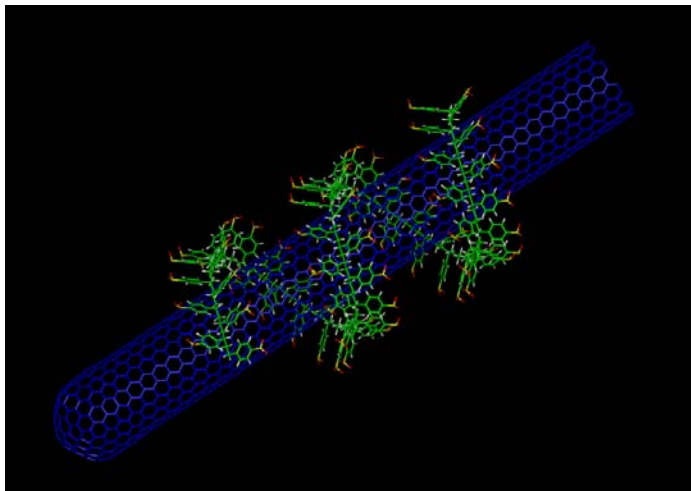

Acknowledgements

This program was made possible by the tireless dedication of the following Garcia MRSEC graduate students, associates and faculty.

Graduate Students

Xiao-Hua Fang
Xuesong Hu
John Luckner Jerome
Bin-Quan Li
Song-Feng Li
Si Mayu
Sarika Sharma
Young-Soo Seo
Yan-Tien Wang
Jean Harry Xavier
Wenhua Zhang

Post-Docs

Nadine Perdonet

Faculty and Staff

Shouren Ge
Wentao Li
Vladimir Samuilov
Henry White
Kowei Lin

We wish to thank the following for their support of the Garcia Center Scholars Program.

The National Science Foundation
Bay Shore High School Advanced Research Program
SUNY AGEF
SUNY Step Program